

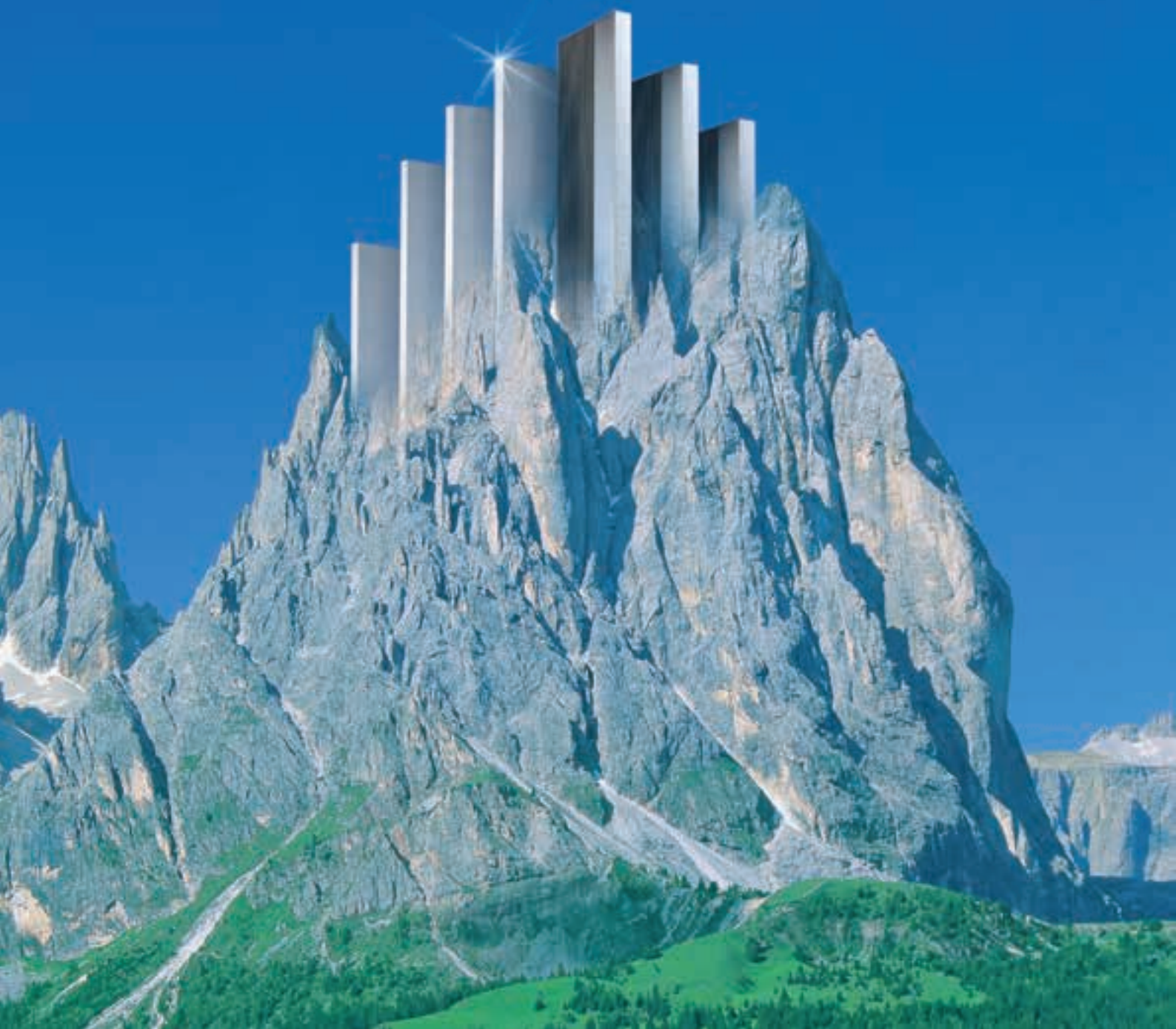

**ILMA<sup>®</sup>**

***INNOVATION SYSTEMS***





*Presente sul mercato nazionale e internazionale da oltre 25 anni, ILMA è oggi una delle aziende più conosciute e stimate nella costruzione di utensili per la lavorazione del legno.*

*Forte di un team giovane e dinamico, abbiamo da sempre attribuito un'importanza fondamentale alla qualità, scegliendo di costruire i nostri utensili in Italia, con materiali certificati;*

*l'organizzazione produttiva, flessibile come oggi il mercato richiede, ci permette di servire i clienti in modo veloce adattandoci anche alle esigenze più particolari.*



*From more than 25 years in the national and international market, ILMA is leader in production of woodworking tools.*

*With a young and dynamic team, we've always conferred value on quality, choosing to manufacture our tools in Italy, with certified material; with our production organization, flexible as market required, we can guarantee to our customers an excellent sale service, for special requirement too.*



*Seit mehr als 25 Jahren auf dem nationalen und internationalen Markt vertreten, ist ILMA heute einer der bekanntesten und angesehensten Hersteller von Messern für Holzverarbeitende Maschinen.*

*Gestützt auf ein junges, dynamisches Team haben wir immer schon der Qualität grundsätzliche Bedeutung beigemessen und deshalb beschlossen, unsere Werkzeuge mit zertifizierten Materialien in Italien zu fertigen. Durch die flexibel auf alle Marktentwicklungen reagierende Organisation unseres Produktionsprozesses können wir Kundenwünsche rasch umsetzen und dabei auch den speziellsten Anforderungen gerecht werden.*



*Presente en el mercado nacional e internacional desde hace más de 25 años, ILMA es hoy una de las empresas más conocidas y apreciadas en la fabricación de herramientas para la madera.*

*Con la fuerza de un equipo joven y dinámico, hemos otorgado siempre una importancia fundamental a la calidad, eligiendo fabricar nuestros utensilios en Italia, con materiales certificados; la organización productiva, flexible como hoyen día exige el mercado, nos permite servir a los clientes de una manera rápida, adaptándonos también a las necesidades más especiales.*



*Наша компания работает на национальном и международном рынках уже более 25 лет, в настоящее время ILMA один из ведущих производителей режущего инструмента для деревообработки.*

*ILMA – это молодая и динамичная команда специалистов, которая всегда придает большое значение качеству, предпочитая изготавливать весь инструмент в Италии, из сертифицированных материалов. Благодаря гибкой организации производства, мы можем уверенно идти в ногу с современным рынком и оперативно обслуживать клиентов, быстро адаптируясь к потребностям заказчика.*

# Made



Scegliete "Made in Italy":  
troverete in ILMA il miglior  
partner per i Vs. affari.



Choose "Made in Italy":  
you'll find in our firm,  
the best partner for your business.

# in



Wählen Sie die Sicherheit  
des "Made in Italy": finden  
Sie in uns den idealen  
Geschäftspartner.



Elijan "Made in Italy":  
encontrarán en ILMA el mejor  
socio para sus negocios.



Выберите: "Сделано в Италии" :  
и найдёте ILMA, лучшего  
партнера для Вашего бизнеса.

# Italy

**Coltelli per piallatrici**  
*Thin planer knives*  
*Hobelmesser*  
*Cuchillas para cepilladoras*  
*Строгальные ножи*

... 4 

**Barre rettangolari HSS**  
*HSS rectangular bars*  
*Rechtecksstangen HSS*  
*Barras rectangulares HSS*  
*Прямоугольные пластины HSS*

... 28 

**Coltelli rigati**  
*Corrugated knives*  
*Blanketts*  
*Cuchillas corrugadas*  
*Бланкетные ножи*

... 29 

**Coltelli reversibili HW**  
*HW Reversible knives*  
*HW Messer für Hobelsysteme*  
*Cuchillas reversibles HW*  
*Сменные пластины HW*

... 37 

**Teste portacoltelli**  
*Cutter heads*  
*Schneidköpfe*  
*Cabezales portacuchillas*  
*Барабаны под строгальные ножи, под бланкетные ножи*

... 49 

**Frese per giunzioni**  
*Finger joint brazed cutters*  
*Minizinkenfräser*  
*Fresas para empalme*  
*Фрезы для сращивания*

... 60 

**Punte e frese**  
*Drill bits, router bits*  
*Düdelbohrer, Vollhartmetallfräser*  
*Broca, Fresas*  
*Фрезы и сверла*

... 61 

**Lame per seghe a nastro**  
*Blades for wood band saws*  
*Bandsägeblätter*  
*Cuchillas para sierra de cinta*  
*Ленточные пилы*

... 66 

**Lame circolari**  
*Circular saw blades*  
*Kreissägeblatt*  
*Noja de sierra*  
*Дисковые пилы*

... 67 

## COLTELLI PIALLA PER LEGNI TENERI

Thin planer knives for soft wood

Hobelmesser für Weichholz

Cuchillas para cepilladoras para madera blanda

Строгальные ножи для мягких пород древесины

# Cr 13%

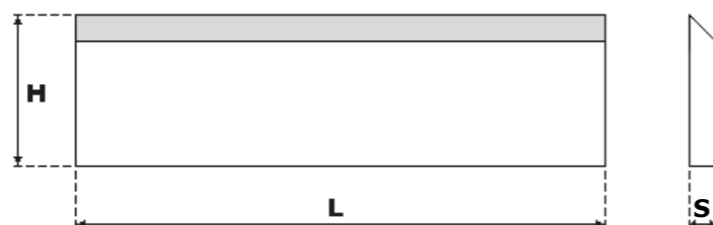

CODICE	MISURA (LxHxS) mm	CODICE	MISURA (LxHxS) mm	CODICE	MISURA (LxHxS) mm
C120203	120x20x3	C350203	350x20x3	C530203	530x20x3
C120253	120x25x3	C350253	350x25x3	C530253	530x25x3
C120303	120x30x3	C350303	350x30x3	C530303	530x30x3
C120353	120x35x3	C350353	350x35x3	C530353	530x35x3
C150203	150x20x3	C400203	400x20x3	C600203	600x20x3
C150253	150x25x3	C400253	400x25x3	C600253	600x25x3
C150303	150x30x3	C400303	400x30x3	C600303	600x30x3
C150353	150x35x3	C400353	400x35x3	C600353	600x35x3
C180203	180x20x3	C410203	410x20x3	C630203	630x20x3
C180253	180x25x3	C410253	410x25x3	C630253	630x25x3
C180303	180x30x3	C410303	410x30x3	C630303	630x30x3
C180353	180x35x3	C410353	410x35x3	C630353	630x35x3
C230203	230x20x3	C500203	500x20x3	C700203	700x20x3
C230253	230x25x3	C500253	500x25x3	C700253	700x25x3
C230303	230x30x3	C500303	500x30x3	C700303	700x30x3
C230353	230x35x3	C500353	500x35x3	C700353	700x35x3
C260203	260x20x3	C510203	510x20x3	C800203	800x20x3
C260253	260x25x3	C510253	510x25x3	C800253	800x25x3
C260303	260x30x3	C510303	510x30x3	C800303	800x30x3
C260353	260x35x3	C510353	510x35x3	C800353	800x35x3
C300203	300x20x3	C520203	520x20x3	C1080203	1080x20x3
C300253	300x25x3	C520253	520x25x3	C1080253	1080x25x3
C300303	300x30x3	C520303	520x30x3	C1080303	1080x30x3
C300353	300x35x3	C520353	520x35x3	C1080353	1080x35x3

## COLTELLI PIALLA PER LEGNI MEDIO/TENERI

Thin planer knives for medium/soft wood

Hobelmesser für Mittleresholz/Weichholz

Cuchillas para cepilladoras para madera mediana/ blanda

Строгальные ножи для древесины средних/мягких пород

# HP

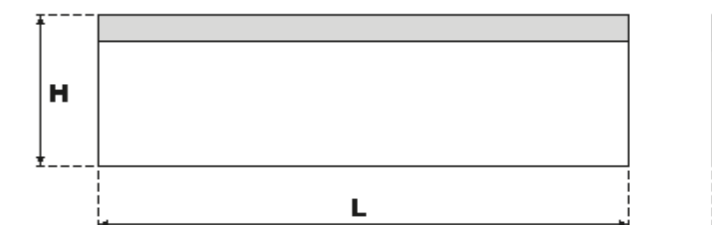

CODICE	MISURA (LxHxS) mm	CODICE	MISURA (LxHxS) mm	CODICE	MISURA (LxHxS) mm
HP120203	120x20x3	HP350203	350x20x3	HP530203	530x20x3
HP120253	120x25x3	HP350253	350x25x3	HP530253	530x25x3
HP120303	120x30x3	HP350303	350x30x3	HP530303	530x30x3
HP120353	120x35x3	HP350353	350x35x3	HP530353	530x35x3
HP150203	150x20x3	HP400203	400x20x3	HP600203	600x20x3
HP150253	150x25x3	HP400253	400x25x3	HP600253	600x25x3
HP150303	150x30x3	HP400303	400x30x3	HP600303	600x30x3
HP150353	150x35x3	HP400353	400x35x3	HP600353	600x35x3
HP180203	180x20x3	HP410203	410x20x3	HP630203	630x20x3
HP180253	180x25x3	HP410253	410x25x3	HP630253	630x25x3
HP180303	180x30x3	HP410303	410x30x3	HP630303	630x30x3
HP180353	180x35x3	HP410353	410x35x3	HP630353	630x35x3
HP230203	230x20x3	HP500203	500x20x3	HP700203	700x20x3
HP230253	230x25x3	HP500253	500x25x3	HP700253	700x25x3
HP230303	230x30x3	HP500303	500x30x3	HP700303	700x30x3
HP230353	230x35x3	HP500353	500x35x3	HP700353	700x35x3
HP260203	260x20x3	HP510203	510x20x3	HP800203	800x20x3
HP260253	260x25x3	HP510253	510x25x3	HP800253	800x25x3
HP260303	260x30x3	HP510303	510x30x3	HP800303	800x30x3
HP260353	260x35x3	HP510353	510x35x3	HP800353	800x35x3
HP300203	300x20x3	HP520203	520x20x3	HP1080203	1080x20x3
HP300253	300x25x3	HP520253	520x25x3	HP1080253	1080x25x3
HP300303	300x30x3	HP520303	520x30x3	HP1080303	1080x30x3
HP300353	300x35x3	HP520353	520x35x3	HP1080353	1080x35x3

## COLTELLI PIALLA UNIVERSALI

Thin planer knives universal quality

Hobelmesser universelle Qualität

Cuchillas para cepilladoras calidad universal

Строгальные ножи универсальное качество

## HSS GREEN LINE

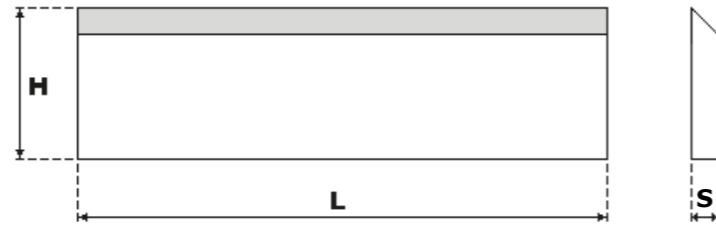

CODICE	MISURA (LxHxS) mm	CODICE	MISURA (LxHxS) mm	CODICE	MISURA (LxHxS) mm
HGL120203	120x20x3	HGL350203	350x20x3	HGL530203	530x20x3
HGL120253	120x25x3	HGL350253	350x25x3	HGL530253	530x25x3
HGL120303	120x30x3	HGL350303	350x30x3	HGL530303	530x30x3
HGL120353	120x35x3	HGL350353	350x35x3	HGL530353	530x35x3
HGL150203	150x20x3	HGL400203	400x20x3	HGL600203	600x20x3
HGL150253	150x25x3	HGL400253	400x25x3	HGL600253	600x25x3
HGL150303	150x30x3	HGL400303	400x30x3	HGL600303	600x30x3
HGL150353	150x35x3	HGL400353	400x35x3	HGL600353	600x35x3
HGL180203	180x20x3	HGL410203	410x20x3	HGL630203	630x20x3
HGL180253	180x25x3	HGL410253	410x25x3	HGL630253	630x25x3
HGL180303	180x30x3	HGL410303	410x30x3	HGL630303	630x30x3
HGL180353	180x35x3	HGL410353	410x35x3	HGL630353	630x35x3
HGL230203	230x20x3	HGL500203	500x20x3	HGL700203	700x20x3
HGL230253	230x25x3	HGL500253	500x25x3	HGL700253	700x25x3
HGL230303	230x30x3	HGL500303	500x30x3	HGL700303	700x30x3
HGL230353	230x35x3	HGL500353	500x35x3	HGL700353	700x35x3
HGL260203	260x20x3	HGL510203	510x20x3	HGL800203	800x20x3
HGL260253	260x25x3	HGL510253	510x25x3	HGL800253	800x25x3
HGL260303	260x30x3	HGL510303	510x30x3	HGL800303	800x30x3
HGL260353	260x35x3	HGL510353	510x35x3	HGL800353	800x35x3
HGL300203	300x20x3	HGL520203	520x20x3	HGL1080203	1080x20x3
HGL300253	300x25x3	HGL520253	520x25x3	HGL1080253	1080x25x3
HGL300303	300x30x3	HGL520303	520x30x3	HGL1080303	1080x30x3
HGL300353	300x35x3	HGL520353	520x35x3	HGL1080353	1080x35x3

## COLTELLI PIALLA PER LEGNI DURI

Thin planer knives for hard wood

Hobelmesser für Hartholz

Cuchillas para cepilladoras para madero dura

Строгальные ножи для твердых пород древесины

## HSS 18%

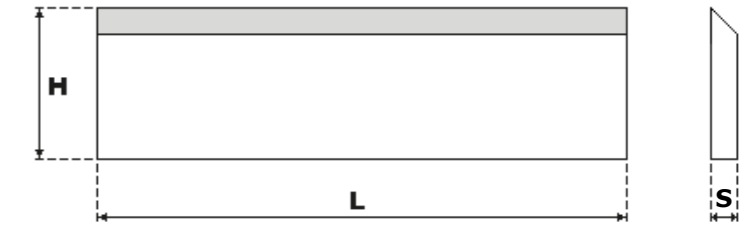

CODICE	MISURA (LxHxS) mm	CODICE	MISURA (LxHxS) mm	CODICE	MISURA (LxHxS) mm
H120203	120x20x3	H350203	350x20x3	H530203	530x20x3
H120253	120x25x3	H350253	350x25x3	H530253	530x25x3
H120303	120x30x3	H350303	350x30x3	H530303	530x30x3
H120353	120x35x3	H350353	350x35x3	H530353	530x35x3
H150203	150x20x3	H400203	400x20x3	H600203	600x20x3
H150253	150x25x3	H400253	400x25x3	H600253	600x25x3
H150303	150x30x3	H400303	400x30x3	H600303	600x30x3
H150353	150x35x3	H400353	400x35x3	H600353	600x35x3
H180203	180x20x3	H410203	410x20x3	H630203	630x20x3
H180253	180x25x3	H410253	410x25x3	H630253	630x25x3
H180303	180x30x3	H410303	410x30x3	H630303	630x30x3
H180353	180x35x3	H410353	410x35x3	H630353	630x35x3
H230203	230x20x3	H500203	500x20x3	H700203	700x20x3
H230253	230x25x3	H500253	500x25x3	H700253	700x25x3
H230303	230x30x3	H500303	500x30x3	H700303	700x30x3
H230353	230x35x3	H500353	500x35x3	H700353	700x35x3
H260203	260x20x3	H510203	510x20x3	H800203	800x20x3
H260253	260x25x3	H510253	510x25x3	H800253	800x25x3
H260303	260x30x3	H510303	510x30x3	H800303	800x30x3
H260353	260x35x3	H510353	510x35x3	H800353	800x35x3
H300203	300x20x3	H520203	520x20x3	H1080203	1080x20x3
H300253	300x25x3	H520253	520x25x3	H1080253	1080x25x3
H300303	300x30x3	H520303	520x30x3	H1080303	1080x30x3
H300353	300x35x3	H520353	520x35x3	H1080353	1080x35x3

## COLTELLI PIALLA RIVESTITI

Coated planer knives

Beschichtete Hobelmesser

Cuchillas para cepilladoras recubiertas

Строгальные ножи специальное покрытие

покpытие

## RADIS LINE

High quality performance

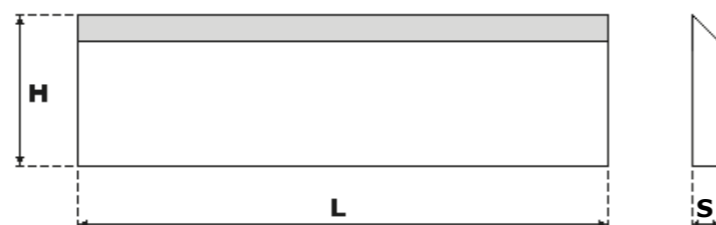

CODICE	MISURA (LxHxS) mm	CODICE	MISURA (LxHxS) mm	CODICE	MISURA (LxHxS) mm
RD120203	120x20x3	RD350203	350x20x3	RD530203	530x20x3
RD120253	120x25x3	RD350253	350x25x3	RD530253	530x25x3
RD120303	120x30x3	RD350303	350x30x3	RD530303	530x30x3
RD120353	120x35x3	RD350353	350x35x3	RD530353	530x35x3
RD150203	150x20x3	RD400203	400x20x3	RD600203	600x20x3
RD150253	150x25x3	RD400253	400x25x3	RD600253	600x25x3
RD150303	150x30x3	RD400303	400x30x3	RD600303	600x30x3
RD150353	150x35x3	RD400353	400x35x3	RD600353	600x35x3
RD180203	180x20x3	RD410203	410x20x3	RD630203	630x20x3
RD180253	180x25x3	RD410253	410x25x3	RD630253	630x25x3
RD180303	180x30x3	RD410303	410x30x3	RD630303	630x30x3
RD180353	180x35x3	RD410353	410x35x3	RD630353	630x35x3
RD230203	230x20x3	RD500203	500x20x3		
RD230253	230x25x3	RD500253	500x25x3		
RD230303	230x30x3	RD500303	500x30x3		
RD230353	230x35x3	RD500353	500x35x3		
RD260203	260x20x3	RD510203	510x20x3		
RD260253	260x25x3	RD510253	510x25x3		
RD260303	260x30x3	RD510303	510x30x3		
RD260353	260x35x3	RD510353	510x35x3		
RD300203	300x20x3	RD520203	520x20x3		
RD300253	300x25x3	RD520253	520x25x3		
RD300303	300x30x3	RD520303	520x30x3		
RD300353	300x35x3	RD520353	520x35x3		

## COLTELLI PIALLA CON METALLO DURO

T.C.T. planer knives

HM-Bestückte Hobelmesser

Cuchillas para cepilladoras con metal duro

Строгальные ножи с твердым металлом

металлом

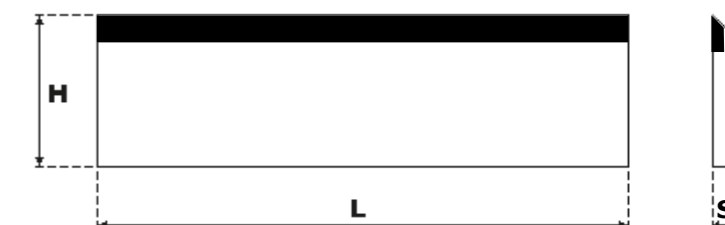

CODICE	MISURA (LxHxS) mm	CODICE	MISURA (LxHxS) mm	CODICE	MISURA (LxHxS) mm
HM120203	120x20x3	HM350203	350x20x3	HM530203	530x20x3
HM120253	120x25x3	HM350253	350x25x3	HM530253	530x25x3
HM120303	120x30x3	HM350303	350x30x3	HM530303	530x30x3
HM120353	120x35x3	HM350353	350x35x3	HM530353	530x35x3
HM150203	150x20x3	HM400203	400x20x3	HM600203	600x20x3
HM150253	150x25x3	HM400253	400x25x3	HM600253	600x25x3
HM150303	150x30x3	HM400303	400x30x3	HM600303	600x30x3
HM150353	150x35x3	HM400353	400x35x3	HM600353	600x35x3
HM180203	180x20x3	HM410203	410x20x3	HM630203	630x20x3
HM180253	180x25x3	HM410253	410x25x3	HM630253	630x25x3
HM180303	180x30x3	HM410303	410x30x3	HM630303	630x30x3
HM180353	180x35x3	HM410353	410x35x3	HM630353	630x35x3
HM230203	230x20x3	HM500203	500x20x3	HM700203	700x20x3
HM230253	230x25x3	HM500253	500x25x3	HM700253	700x25x3
HM230303	230x30x3	HM500303	500x30x3	HM700303	700x30x3
HM230353	230x35x3	HM500353	500x35x3	HM700353	700x35x3
HM260203	260x20x3	HM510203	510x20x3	HM800203	800x20x3
HM260253	260x25x3	HM510253	510x25x3	HM800253	800x25x3
HM260303	260x30x3	HM510303	510x30x3	HM800303	800x30x3
HM260353	260x35x3	HM510353	510x35x3	HM800353	800x35x3
HM300203	300x20x3	HM520203	520x20x3	HM1050203	1050x20x3
HM300253	300x25x3	HM520253	520x25x3	HM1050253	1050x25x3
HM300303	300x30x3	HM520303	520x30x3	HM1050303	1050x30x3
HM300353	300x35x3	HM520353	520x35x3	HM1050353	1050x35x3

HM

## COLTELLI PIALLA PER SISTEMA TERSA

Thin planer knives for Tersa System

Hobelmesser für System Tersa

Cuchillas para cepilladoras para Sistema Tersa

Строгальные ножи для системы Tersa

# HSS

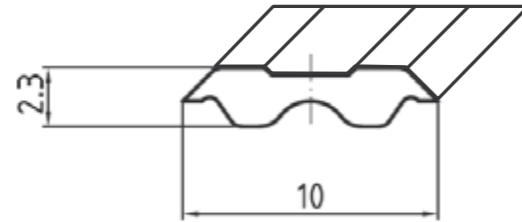

### ORIGINAL VERSION

CODICE	MISURA (mm)
HTSOV60	60X10X2,3
HTSOV80	80X10X2,3
HTSOV90	90X10X2,3
HTSOV100	100X10X2,3
HTSOV110	110X10X2,3
HTSOV115	115X10X2,3
HTSOV120	120X10X2,3
HTSOV130	130X10X2,3
HTSOV140	140X10X2,3
HTSOV150	150X10X2,3
HTSOV160	160X10X2,3
HTSOV170	170X10X2,3
HTSOV180	180X10X2,3
HTSOV190	190X10X2,3
HTSOV200	200X10X2,3
HTSOV210	210X10X2,3
HTSOV220	220X10X2,3
HTSOV230	230X10X2,3
HTSOV240	240X10X2,3
HTSOV250	250X10X2,3
HTSOV260	260X10X2,3
HTSOV270	270X10X2,3
HTSOV280	280X10X2,3

CODICE	MISURA (mm)
HTSOV300	300X10X2,3
HTSOV310	310X10X2,3
HTSOV320	320X10X2,3
HTSOV330	330X10X2,3
HTSOV350	350X10X2,3
HTSOV360	360X10X2,3
HTSOV400	400X10X2,3
HTSOV410	410X10X2,3
HTSOV420	420X10X2,3
HTSOV430	430X10X2,3
HTSOV450	450X10X2,3
HTSOV500	500X10X2,3
HTSOV510	510X10X2,3
HTSOV520	520X10X2,3
HTSOV530	530X10X2,3
HTSOV540	540X10X2,3
HTSOV600	600X10X2,3
HTSOV610	610X10X2,3
HTSOV630	630X10X2,3
HTSOV635	635X10X2,3
HTSOV640	640X10X2,3
HTSOV650	650X10X2,3

## COLTELLI PIALLA PER SISTEMA TERSA

Thin planer knives for Tersa System

Hobelmesser für System Tersa

Cuchillas para cepilladoras para Sistema Tersa

Строгальные ножи для системы Tersa

# HSS

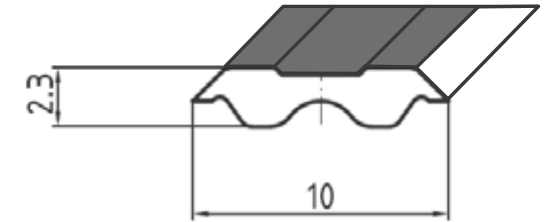

### STANDARD VERSION

CODICE	MISURA (mm)
HTS60	60X10X2,3
HTS80	80X10X2,3
HTS90	90X10X2,3
HTS100	100X10X2,3
HTS110	110X10X2,3
HTS115	115X10X2,3
HTS120	120X10X2,3
HTS130	130X10X2,3
HTS140	140X10X2,3
HTS150	150X10X2,3
HTS160	160X10X2,3
HTS170	170X10X2,3
HTS180	180X10X2,3
HTS190	190X10X2,3
HTS200	200X10X2,3
HTS210	210X10X2,3
HTS220	220X10X2,3
HTS230	230X10X2,3
HTS240	240X10X2,3
HTS250	250X10X2,3
HTS260	260X10X2,3
HTS270	270X10X2,3
HTS280	280X10X2,3

CODICE	MISURA (mm)
HTS300	300X10X2,3
HTS310	310X10X2,3
HTS320	320X10X2,3
HTS330	330X10X2,3
HTS350	350X10X2,3
HTS360	360X10X2,3
HTS400	400X10X2,3
HTS410	410X10X2,3
HTS420	420X10X2,3
HTS430	430X10X2,3
HTS450	450X10X2,3
HTS500	500X10X2,3
HTS510	510X10X2,3
HTS520	520X10X2,3
HTS530	530X10X2,3
HTS540	540X10X2,3
HTS600	600X10X2,3
HTS610	610X10X2,3
HTS630	630X10X2,3
HTS635	635X10X2,3
HTS640	640X10X2,3
HTS650	650X10X2,3
BHTS120	120 mt 10x2,3

## COLTELLI PIALLA PER SISTEMA TERSA

Thin planer knives for Tersa System

Hobelmesser für System Tersa

Cuchillas para cepilladoras para Sistema Tersa

Строгальные ножи для системы Tersa

## M42

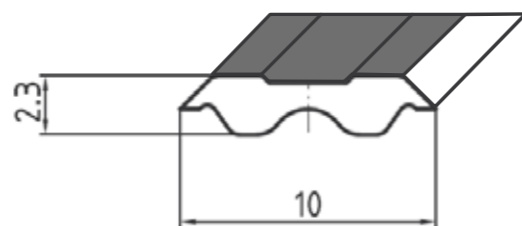

CODICE	MISURA (mm)	CODICE	MISURA (mm)
M42TS60	60X10X2,3	M42TS310	310X10X2,3
M42TS80	80X10X2,3	M42TS320	320X10X2,3
M42TS90	90X10X2,3	M42TS330	330X10X2,3
M42TS100	100X10X2,3	M42TS350	350X10X2,3
M42TS110	110X10X2,3	M42TS360	360X10X2,3
M42TS115	115X10X2,3	M42TS400	400X10X2,3
M42TS120	120X10X2,3	M42TS410	410X10X2,3
M42TS130	130X10X2,3	M42TS420	420X10X2,3
M42TS140	140X10X2,3	M42TS430	430X10X2,3
M42TS150	150X10X2,3	M42TS450	450X10X2,3
M42TS160	160X10X2,3	M42TS500	500X10X2,3
M42TS170	170X10X2,3	M42TS510	510X10X2,3
M42TS180	180X10X2,3	M42TS520	520X10X2,3
M42TS190	190X10X2,3	M42TS530	530X10X2,3
M42TS200	200X10X2,3	M42TS540	540X10X2,3
M42TS210	210X10X2,3	M42TS600	600X10X2,3
M42TS220	220X10X2,3	M42TS610	610X10X2,3
M42TS230	230X10X2,3	M42TS630	630X10X2,3
M42TS240	240X10X2,3	M42TS635	635X10X2,3
M42TS250	250X10X2,3	M42TS640	640X10X2,3
M42TS260	260X10X2,3	M42TS650	650X10X2,3
M42TS270	270X10X2,3		
M42TS280	280X10X2,3	BM42TS60	Mt.60 10x2,3
M42TS300	300X10X2,3	BM42TS120	Mt.120 10x2,3

## COLTELLI PIALLA PER SISTEMA TERSA HM INTEGRALE

Thin planer knives for Tersa System solid carbide

Vollhartmetall Hobelmesser für System Tersa

Cuchillas para cepilladoras para Sistema Tersa metal duro integral

Строгальные ножи для системы Tersa хорошего качества

## HM

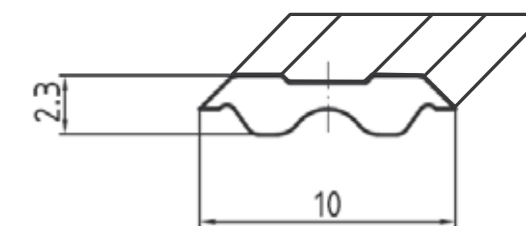

CODICE	MISURA (mm)	CODICE	MISURA (mm)
HMTS60	60X10X2,3	HMTS300	300X10X2,3
HMTS80	80X10X2,3	HMTS310	310X10X2,3
HMTS90	90X10X2,3	HMTS320	320X10X2,3
HMTS100	100X10X2,3	HMTS330	330X10X2,3
HMTS110	110X10X2,3	HMTS350	350X10X2,3
HMTS115	115X10X2,3	HMTS360	360X10X2,3
HMTS120	120X10X2,3	HMTS400	400X10X2,3
HMTS130	130X10X2,3	HMTS410	410X10X2,3
HMTS140	140X10X2,3	HMTS420	420X10X2,3
HMTS150	150X10X2,3	HMTS430	430X10X2,3
HMTS160	160X10X2,3	HMTS450	450X10X2,3
HMTS170	170X10X2,3	HMTS500	500X10X2,3
HMTS180	180X10X2,3	HMTS510	510X10X2,3
HMTS190	190X10X2,3	HMTS520	520X10X2,3
HMTS200	200X10X2,3	HMTS530	530X10X2,3
HMTS210	210X10X2,3	HMTS540	540X10X2,3
HMTS220	220X10X2,3	HMTS600	600X10X2,3
HMTS230	230X10X2,3	HMTS610	610X10X2,3
HMTS240	240X10X2,3	HMTS630	630X10X2,3
HMTS250	250X10X2,3	HMTS635	635X10X2,3
HMTS260	260X10X2,3	HMTS640	640X10X2,3
HMTS270	270X10X2,3	HMTS650	650X10X2,3
HMTS280	280X10X2,3		

## COLTELLI PIALLA PER SISTEMA CENTROLOCK

Thin planer knives for Centrolock System

Hobelmesser für System Centrolock

Cuchillas para cepilladoras para Sistema Centrolock

Строгальные ножи для системы Centrolock

# HSS

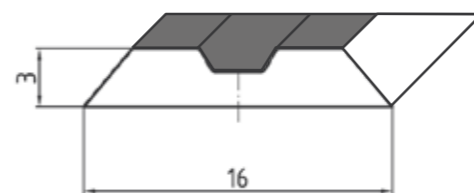
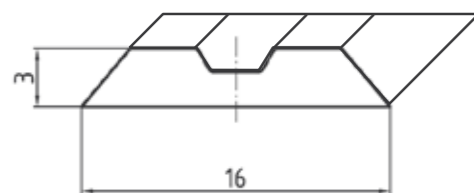

### ORIGINAL VERSION

### STANDARD VERSION

## COLTELLI PIALLA PER SISTEMA CENTROLOCK HM INTEGRALE

# HM

Thin planer knives for Centrolock System solid carbide

Vollhartmetal Hobelmesser für System Centrolock

Cuchillas para cepilladoras para Sistema Centrolock metal duro integral

Строгальные ножи для системы Centrolock хорошего качества

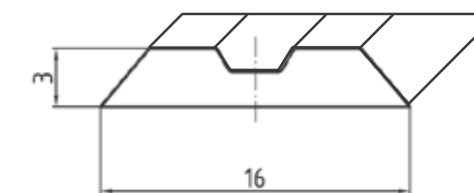

**CODICE**      **MISURA**  
(mm)

HCLOV10	10X16X3
HCLOV20	20X16X3
HCLOV30	30X16X3
HCLOV40	40X16X3
HCLOV50	50X16X3
HCLOV60	60X16X3
HCLOV65	65X16X3
HCLOV80	80X16X3
HCLOV100	100X16X3
HCLOV115	115X16X3
HCLOV130	130X16X3
HCLOV140	140X16X3
HCLOV150	150X16X3
HCLOV160	160X16X3
HCLOV170	170X16X3
HCLOV180	180X16X3
HCLOV190	190X16X3
HCLOV210	210X16X3
HCLOV220	220X16X3
HCLOV230	230X16X3
HCLOV235	235X16X3
HCLOV240	240X16X3
HCLOV260	260X16X3
HCLOV270	270X16X3
HCLOV300	300X16X3
HCLOV310	310X16X3
HCLOV460	460X16X3
HCLOV650	650X16X3

**CODICE**      **MISURA**  
(mm)

HCL10	10X16X3
HCL20	20X16X3
HCL30	30X16X3
HCL40	40X16X3
HCL50	50X16X3
HCL60	60X16X3
HCL65	65X16X3
HCL80	80X16X3
HCL100	100X16X3
HCL115	115X16X3
HCL130	130X16X3
HCL140	140X16X3
HCL150	150X16X3
HCL160	160X16X3
HCL170	170X16X3
HCL180	180X16X3
HCL190	190X16X3
HCL210	210X16X3
HCL220	220X16X3
HCL230	230X16X3
HCL235	235X16X3
HCL240	240X16X3
HCL260	260X16X3
HCL270	270X16X3
HCL300	300X16X3
HCL310	310X16X3
HCL460	460X16X3
HCL650	650X16X3

**CODICE**      **MISURA**  
(mm)

HMCL10	10X16X3
HMCL20	20X16X3
HMCL30	30X16X3
HMCL40	40X16X3
HMCL50	50X16X3
HMCL60	60X16X3
HMCL65	65X16X3
HMCL80	80X16X3
HMCL100	100X16X3
HMCL115	115X16X3
HMCL130	130X16X3
HMCL140	140X16X3
HMCL150	150X16X3
HMCL160	160X16X3
HMCL170	170X16X3
HMCL180	180X16X3
HMCL190	190X16X3
HMCL210	210X16X3
HMCL220	220X16X3
HMCL230	230X16X3
HMCL235	235X16X3
HMCL240	240X16X3
HMCL260	260X16X3
HMCL270	270X16X3
HMCL300	300X16X3
HMCL310	310X16X3
HMCL460	460X16X3
HMCL650	650X16X3

## COLTELLI PIALLA PER SISTEMA CENTROFIX

Thin planer knives for Centrofix System

Hobelmesser für System Centrofix

Cuchillas para cepilladoras para Sistema Centrofix

Строгальные ножи для системы Centrofix

# HSS

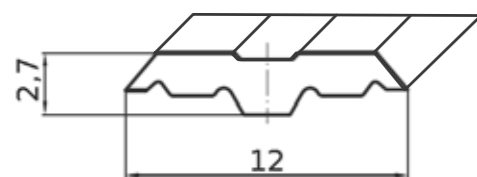

### ORIGINAL VERSION

CODICE	MISURA (mm)
HCFOV50	50X12X2,70
HCFOV80	80X12X2,70
HCFOV100	100X12X2,70
HCFOV120	120X12X2,70
HCFOV130	130X12X2,70
HCFOV136	136X12X2,70
HCFOV150	150X12X2,70
HCFOV170	170X12X2,70
HCFOV180	180X12X2,70
HCFOV190	190X12X2,70
HCFOV210	210X12X2,70
HCFOV230	230X12X2,70
HCFOV240	240X12X2,70
HCFOV310	310X12X2,70
HCFOV400	400X12X2,70
HCFOV410	410X12X2,70
HCFOV420	420X12X2,70
HCFOV430	430X12X2,70
HCFOV500	500X12X2,70
HCFOV510	510X12X2,70
HCFOV520	520X12X2,70
HCFOV530	530X12X2,70
HCFOV540	540X12X2,70
HCFOV630	630X12X2,70
HCFOV640	640X12X2,70
HCFOV650	650X12X2,70

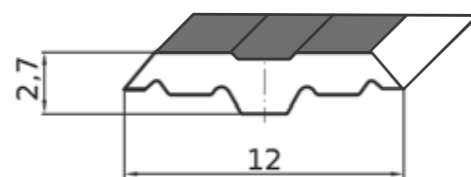

### STANDARD VERSION

CODICE	MISURA (mm)
HCF50	50X12X2,70
HCF80	80X12X2,70
HCF100	100X12X2,70
HCF120	120X12X2,70
HCF130	130X12X2,70
HCF136	136X12X2,70
HCF150	150X12X2,70
HCF170	170X12X2,70
HCF180	180X12X2,70
HCF190	190X12X2,70
HCF210	210X12X2,70
HCF230	230X12X2,70
HCF240	240X12X2,70
HCF310	310X12X2,70
HCF400	400X12X2,70
HCF410	410X12X2,70
HCF420	420X12X2,70
HCF430	430X12X2,70
HCF500	500X12X2,70
HCF510	510X12X2,70
HCF520	520X12X2,70
HCF530	530X12X2,70
HCF540	540X12X2,70
HCF630	630X12X2,70
HCF640	640X12X2,70
HCF650	650X12X2,70

## COLTELLI PIALLA PER SISTEMA CENTROFIX HM INTEGRALE

Thin planer knives for Centrofix System solid carbide

Vollhartmetal Hobelmesser für System Centrofix

Cuchillas para cepilladoras para Sistema Centrofix metal duro integral

Строгальные ножи для системы Centrofix хорошего качества

# HM

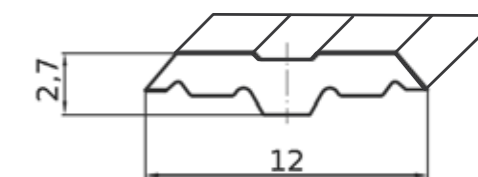

CODICE	MISURA (mm)
--------	----------------

HMCF50	50X12X2,70
HMCF80	80X12X2,70
HMCF100	100X12X2,70
HMCF120	120X12X2,70
HMCF130	130X12X2,70
HMCF136	136X12X2,70
HMCF150	150X12X2,70
HMCF170	170X12X2,70
HMCF180	180X12X2,70
HMCF190	190X12X2,70
HMCF210	210X12X2,70
HMCF230	230X12X2,70
HMCF240	240X12X2,70
HMCF310	310X12X2,70
HMCF400	400X12X2,70
HMCF410	410X12X2,70
HMCF420	420X12X2,70
HMCF430	430X12X2,70
HMCF500	500X12X2,70
HMCF510	510X12X2,70
HMCF520	520X12X2,70
HMCF530	530X12X2,70
HMCF540	540X12X2,70
HMCF630	630X12X2,70
HMCF640	640X12X2,70
HMCF650	650X12X2,70

## COLTELLI PIALLA PER SISTEMA TERMINUS

Thin planer knives for Terminus System

Hobelmesser für System Terminus

Cuchillas para cepilladoras para Sistema Terminus

Строгальные ножи для системы Terminus

# HSS

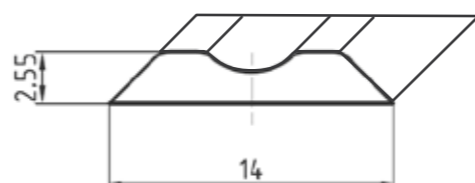

### ORIGINAL VERSION

CODICE	MISURA (mm)	CODICE	MISURA (mm)
HTROV50	50X14X2,55	HTROV275	275X14X2,55
HTROV60	60X14X2,55	HTROV280	280X14X2,55
HTROV80	80X14X2,55	HTROV300	300X14X2,55
HTROV100	100X14X2,55	HTROV310	310X14X2,55
HTROV110	110X14X2,55	HTROV330	330X14X2,55
HTROV120	120X14X2,55	HTROV350	350X14X2,55
HTROV130	130X14X2,55	HTROV360	360X14X2,55
HTROV136	136X14X2,55	HTROV400	400X14X2,55
HTROV140	140X14X2,55	HTROV410	410X14X2,55
HTROV150	150X14X2,55	HTROV420	420X14X2,55
HTROV160	160X14X2,55	HTROV430	430X14X2,55
HTROV170	170X14X2,55	HTROV450	450X14X2,55
HTROV180	180X14X2,55	HTROV480	480X14X2,55
HTROV190	190X14X2,55	HTROV500	500X14X2,55
HTROV200	200X14X2,55	HTROV510	510X14X2,55
HTROV210	210X14X2,55	HTROV520	520X14X2,55
HTROV220	220X14X2,55	HTROV530	530X14X2,55
HTROV230	230X14X2,55	HTROV610	610X14X2,55
HTROV240	240X14X2,55	HTROV620	620X14X2,55
HTROV250	250X14X2,55	HTROV630	630X14X2,55
HTROV255	255X14X2,55	HTROV640	640X14X2,55
HTROV260	260X14X2,55	HTROV650	650X14X2,55
HTROV270	270X14X2,55		

## COLTELLI PIALLA PER SISTEMA TERMINUS

Thin planer knives for Terminus System

Hobelmesser für System Terminus

Cuchillas para cepilladoras para Sistema Terminus

Строгальные ножи для системы Terminus

# HSS

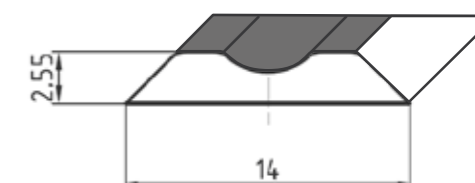

### STANDARD VERSION

CODICE	MISURA (mm)	CODICE	MISURA (mm)
HTR50	50X14X2,55	HTR275	275X14X2,55
HTR60	60X14X2,55	HTR280	280X14X2,55
HTR80	80X14X2,55	HTR300	300X14X2,55
HTR100	100X14X2,55	HTR310	310X14X2,55
HTR110	110X14X2,55	HTR330	330X14X2,55
HTR120	120X14X2,55	HTR350	350X14X2,55
HTR130	130X14X2,55	HTR360	360X14X2,55
HTR136	136X14X2,55	HTR400	400X14X2,55
HTR140	140X14X2,55	HTR410	410X14X2,55
HTR150	150X14X2,55	HTR420	420X14X2,55
HTR160	160X14X2,55	HTR430	430X14X2,55
HTR170	170X14X2,55	HTR450	450X14X2,55
HTR180	180X14X2,55	HTR480	480X14X2,55
HTR190	190X14X2,55	HTR500	500X14X2,55
HTR200	200X14X2,55	HTR510	510X14X2,55
HTR210	210X14X2,55	HTR520	520X14X2,55
HTR220	220X14X2,55	HTR530	530X14X2,55
HTR230	230X14X2,55	HTR610	610X14X2,55
HTR240	240X14X2,55	HTR620	620X14X2,55
HTR250	250X14X2,55	HTR630	630X14X2,55
HTR255	255X14X2,55	HTR640	640X14X2,55
HTR260	260X14X2,55	HTR650	650X14X2,55
HTR270	270X14X2,55		

## COLTELLI PIALLA PER SISTEMA TERMINUS HM INTEGRALE

# HM

Thin planer knives for Terminus System solid carbide

Vollhartmetall Hobelmesser für System Terminus

Cuchillas para cepilladoras para Sistema Terminus metal duro integral

Строгальные ножи для системы Terminus хорошего качества

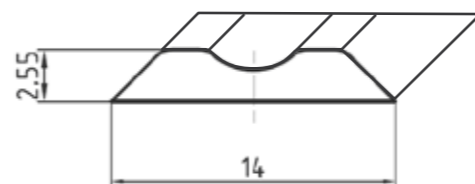

**CODICE**      **MISURA**  
(mm)

HMTR50	50X14X2,55
HMTR60	60X14X2,55
HMTR80	80X14X2,55
HMTR100	100X14X2,55
HMTR110	110X14X2,55
HMTR120	120X14X2,55
HMTR130	130X14X2,55
HMTR136	136X14X2,55
HMTR140	140X14X2,55
HMTR150	150X14X2,55
HMTR160	160X14X2,55
HMTR170	170X14X2,55
HMTR180	180X14X2,55
HMTR190	190X14X2,55
HMTR200	200X14X2,55
HMTR210	210X14X2,55
HMTR220	220X14X2,55
HMTR230	230X14X2,55
HMTR240	240X14X2,55
HMTR250	250X14X2,55
HMTR255	255X14X2,55
HMTR260	260X14X2,55
HMTR270	270X14X2,55

**CODICE**      **MISURA**  
(mm)

HMTR275	275X14X2,55
HMTR280	280X14X2,55
HMTR300	300X14X2,55
HMTR310	310X14X2,55
HMTR330	330X14X2,55
HMTR350	350X14X2,55
HMTR360	360X14X2,55
HMTR400	400X14X2,55
HMTR410	410X14X2,55
HMTR420	420X14X2,55
HMTR430	430X14X2,55
HMTR450	450X14X2,55
HMTR480	480X14X2,55
HMTR500	500X14X2,55
HMTR510	510X14X2,55
HMTR520	520X14X2,55
HMTR530	530X14X2,55
HMTR610	610X14X2,55
HMTR620	620X14X2,55
HMTR630	630X14X2,55
HMTR640	640X14X2,55
HMTR650	650X14X2,55

## COLTELLI PIALLA PER SISTEMA VARIPLAN

# HSS

Thin planer knives for Variplan System

Hobelmesser für System Variplan

Cuchillas para cepilladoras para Sistema Variplan

Строгальные ножи для системы Variplan

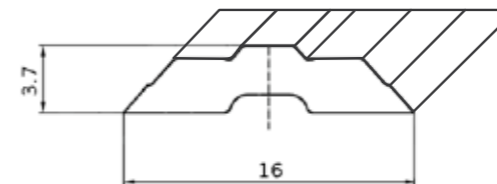

### ORIGINAL VERSION

**CODICE**      **MISURA**  
(mm)

HVPOV60	60X16X3,7
HVPOV80	80X16X3,7
HVPOV100	100X16X3,7
HVPOV120	120X16X3,7
HVPOV130	130X16X3,7
HVPOV150	150X16X3,7
HVPOV170	170X16X3,7
HVPOV180	180X16X3,7
HVPOV190	190X16X3,7
HVPOV210	210X16X3,7
HVPOV230	230X16X3,7
HVPOV240	240X16X3,7
HVPOV400	400X16X3,7
HVPOV410	410X16X3,7
HVPOV420	420X16X3,7
HVPOV430	430X16X3,7
HVPOV500	500X16X3,7
HVPOV510	510X16X3,7
HVPOV520	520X16X3,7
HVPOV530	530X16X3,7
HVPOV540	540X16X3,7
HVPOV600	600X16X3,7
HVPOV610	610X16X3,7
HVPOV630	630X16X3,7
HVPOV640	640X16X3,7

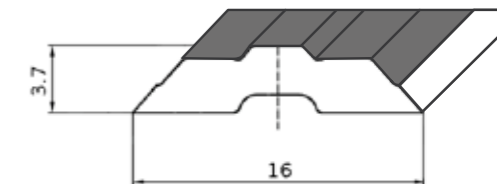

### STANDARD VERSION

**CODICE**      **MISURA**  
(mm)

HVP50	50X16X3,7
HVP60	60X16X3,7
HVP80	80X16X3,7
HVP100	100X16X3,7
HVP120	120X16X3,7
HVP130	130X16X3,7
HVP150	150X16X3,7
HVP170	170X16X3,7
HVP180	180X16X3,7
HVP190	190X16X3,7
HVP210	210X16X3,7
HVP230	230X16X3,7
HVP240	240X16X3,7
HVP400	400X16X3,7
HVP410	410X16X3,7
HVP420	420X16X3,7
HVP430	430X16X3,7
HVP500	500X16X3,7
HVP510	510X16X3,7
HVP520	520X16X3,7
HVP530	530X16X3,7
HVP540	540X16X3,7
HVP600	600X16X3,7
HVP610	610X16X3,7
HVP630	630X16X3,7
HVP640	640X16X3,7

## COLTELLI PIALLA PER SISTEMA VARIPLAN HM INTEGRALE

# HM

Thin planer knives for Variplan System solid carbide

Vollhartmetal Hobelmesser für System Variplan

Cuchillas para cepilladoras para Sistema Variplan metal duro integral

Строгальные ножи для системы Variplan хорошего качества

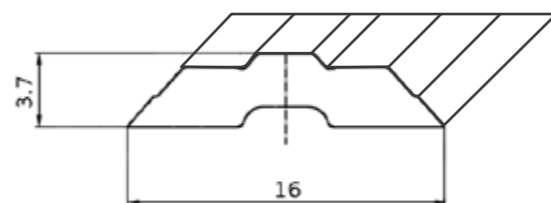

CODICE	MISURA (mm)
HMVP50	50X16X3,7
HMVP60	60X16X3,7
HMVP80	80X16X3,7
HMVP100	100X16X3,7
HMVP120	120X16X3,7
HMVP130	130X16X3,7
HMVP150	150X16X3,7
HMVP170	170X16X3,7
HMVP180	180X16X3,7
HMVP190	190X16X3,7
HMVP210	210X16X3,7
HMVP230	230X16X3,7
HMVP240	240X16X3,7
HMVP400	400X16X3,7
HMVP410	410X16X3,7
HMVP420	420X16X3,7
HMVP430	430X16X3,7
HMVP500	500X16X3,7
HMVP510	510X16X3,7
HMVP520	520X16X3,7
HMVP530	530X16X3,7
HMVP540	540X16X3,7
HMVP600	600X16X3,7
HMVP610	610X16X3,7
HMVP630	630X16X3,7
HMVP640	640X16X3,7

## COLTELLI PIALLA PER SISTEMA SINUS

# HSS

Thin planer knives for Sinus System

Hobelmesser für System Sinus

Cuchillas para cepilladoras para Sistema Sinus

Строгальные ножи для системы Sinus

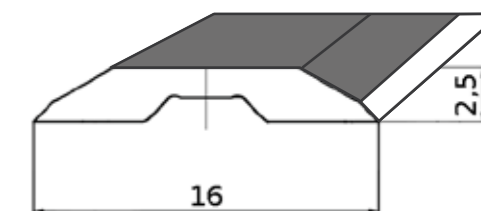

CODICE	MISURA (mm)
HSN80	80X16X2,5
HSN100	100X16X2,5
HSN120	120X16X2,5
HSN130	130X16X2,5
HSN140	140X16X2,5
HSN150	150X16X2,5
HSN160	160X16X2,5
HSN180	180X16X2,5
HSN190	190X16X2,5
HSN200	200X16X2,5
HSN210	210X16X2,5
HSN220	220X16X2,5
HSN230	230X16X2,5
HSN240	240X16X2,5
HSN250	250X16X2,5
HSN260	260X16X2,5
HSN300	300X16X2,5
HSN310	310X16X2,5
HSN400	400X16X2,5
HSN410	410X16X2,5
HSN430	430X16X2,5
HSN500	500X16X2,5
HSN510	510X16X2,5
HSN610	610X16X2,5
HSN630	630X16X2,5
HSN640	640X16X2,5
HSN710	710X16X2,5
HSN1050	1050X16X2,5

## COLTELLI PIALLA PER SISTEMA SINUS HM INTEGRALE

Thin planer knives for Sinus System solid carbide

Vollhartmetall Hobelmesser für System Sinus

Cuchillas para cepilladoras para Sistema Sinus metal duro integral

Строгальные ножи для системы Sinus хорошего качества

# HM

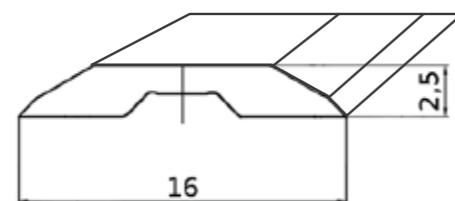

CODICE	MISURA (mm)
HMSN80	80X16X2,5
HMSN100	100X16X2,5
HMSN120	120X16X2,5
HMSN130	130X16X2,5
HMSN140	140X16X2,5
HMSN150	150X16X2,5
HMSN160	160X16X2,5
HMSN180	180X16X2,5
HMSN200	200X16X2,5
HMSN210	210X16X2,5
HMSN220	220X16X2,5
HMSN230	230X16X2,5
HMSN240	240X16X2,5
HMSN250	250X16X2,5
HMSN260	260X16X2,5
HMSN300	300X16X2,5
HMSN310	310X16X2,5
HMSN400	400X16X2,5
HMSN410	410X16X2,5
HMSN430	430X16X2,5
HMSN500	500X16X2,5
HMSN510	510X16X2,5
HMSN610	610X16X2,5
HMSN630	630X16X2,5
HMSN640	640X16X2,5

## COLTELLI PIALLA PER SISTEMA ENSHIN

Thin planer knives for Enshin System

Hobelmesser für System Enshin

Cuchillas para cepilladoras para Sistema Enshin

Строгальные ножи для системы Enshin

# HSS

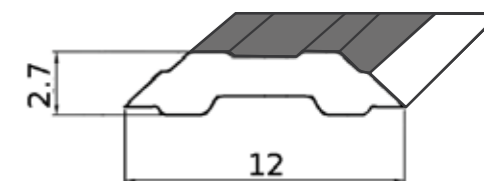

CODICE	MISURA (mm)
HEN80	80X12X2,7
HEN100	100X12X2,7
HEN130	130X12X2,7
HEN150	150X12X2,7
HEN170	170X12X2,7
HEN180	180X12X2,7
HEN190	190X12X2,7
HEN210	210X12X2,7
HEN230	230X12X2,7
HEN240	240X12X2,7
HEN1050	1050X12X2,7
HENB110	Bobina 110m 12X2,7

## COLTELLI PIALLA PER SISTEMA ENSHIN HM INTEGRALE

Thin planer knives for Enshin System solid carbide

Vollhartmetal Hobelmesser für System Enshin

Cuchillas para cepilladoras para Sistema Enshin metal duro integral

Строгальные ножи для системы Enshin хорошего качества

# HM

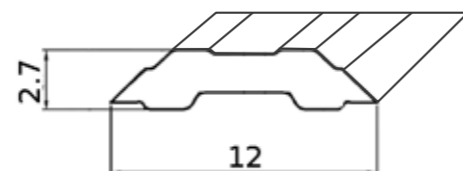

CODICE	MISURA (mm)
HMEN80	80X12X2,7
HMEN100	100X12X2,7
HMEN130	130X12X2,7
HMEN150	150X12X2,7
HMEN170	170X12X2,7
HMEN180	180X12X2,7
HMEN190	190X12X2,7
HMEN210	210X12X2,7
HMEN230	230X12X2,7
HMEN240	240X12X2,7
HMEN640	640X12X2,7

## COLTELLI PIALLA PER SISTEMA BULLDOZER HM INTEGRALE

Thin planer knives for Bulldozer System solid carbide

Vollhartmetal Hobelmesser für System Bulldozer

Cuchillas para cepilladoras para Sistema Bulldozer metal duro integral

Строгальные ножи для системы Bulldozer хорошего качества

# HM

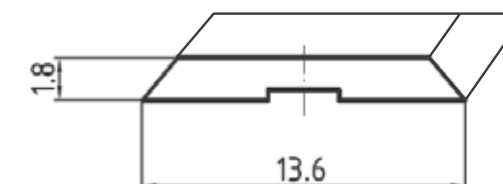

CODICE	MISURA (mm)
HMBZ60	60X13,6X1,8
HMBZ70	70X13,6X1,8
HMBZ80	80X13,6X1,8
HMBZ100	100X13,6X1,8
HMBZ110	110X13,6X1,8
HMBZ120	120X13,6X1,8
HMBZ130	130X13,6X1,8
HMBZ140	140X13,6X1,8
HMBZ150	150X13,6X1,8
HMBZ160	160X13,6X1,8
HMBZ180	180X13,6X1,8
HMBZ190	190X13,6X1,8
HMBZ200	200X13,6X1,8
HMBZ220	220X13,6X1,8
HMBZ230	230X13,6X1,8
HMBZ240	240X13,6X1,8
HMBZ250	250X13,6X1,8
HMBZ260	260X13,6X1,8

## BARRE

Bars  
Rechtecksstangen  
Barras  
Пластины с фаской

## HSS 18%

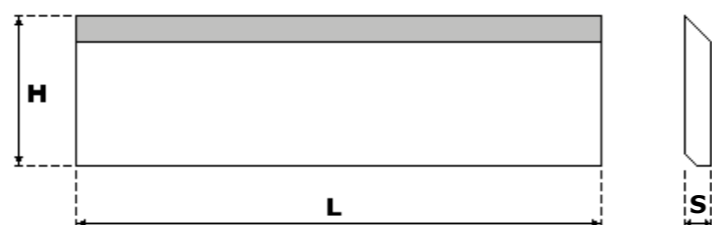

CODICE	MISURA (LxHxS) mm
B650208	650x20x8
B650258	650x25x8
B650308	650x30x8
B650358	650x35x8
B650408	650x40x8
B650458	650x45x8
B650508	650x50x8

CODICE	MISURA (LxHxS) mm
B6502010	650x20x10
B6502510	650x25x10
B6503010	650x30x10
B6503510	650x35x10
B6504010	650x40x10
B6504510	650x45x10
B6505010	650x50x10

## BARRE RETTANGOLARI

Rectangular bars  
Rechtecksstangen  
Barras rectangular  
Пластины с углом 90°

## HSS 18%

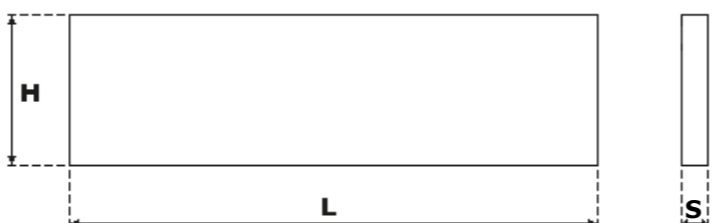

CODICE	MISURA (LxHxS) mm
BR650205	650x20x5
BR650255	650x25x5
BR650305	650x30x5
BR650355	650x35x5
BR650405	650x40x5
BR650455	650x45x5
BR650505	650x50x5
BR650605	650x60x5
BR650705	650x70x5

CODICE	MISURA (LxHxS) mm
BR650208	650x20x8
BR650258	650x25x8
BR650308	650x30x8
BR650358	650x35x8
BR650408	650x40x8
BR650458	650x45x8
BR650508	650x50x8
BR650608	650x60x8
BR650708	650x70x8

CODICE	MISURA (LxHxS) mm
BR650206	650x20x6
BR650256	650x25x6
BR650306	650x30x6
BR650356	650x35x6
BR650406	650x40x6
BR650456	650x45x6
BR650506	650x50x6
BR650606	650x60x6
BR650706	650x70x6

CODICE	MISURA (LxHxS) mm
BR6502010	650x20x10
BR6502510	650x25x10
BR6503010	650x30x10
BR6503510	650x35x10
BR6504010	650x40x10
BR6504510	650x45x10
BR6505010	650x50x10
BR6506010	650x60x10
BR6507010	650x70x10

Misure speciali su richiesta - Special sizes on request - Sonderabmessungen auf Anfrage - medidas especiales sobre pedido - Специальные размеры под заказ

## COLTELLI RIGATI PER LEGNI TENERI

Corrugated knives for soft wood  
Blanketts für Weichholz  
Cuchillas corrugadas para madera blanda  
Бланкетные ножи для мягких пород древесины

## Cr 13%



### Sp. 8mm / Thick 8mm

CODICE	MISURA (LxHxS) mm
C40408	40x40x8
C40508	40x50x8
C40608	40x60x8
C40708	40x70x8

CODICE	MISURA (LxHxS) mm
C150408	150x40x8
C150508	150x50x8
C150608	150x60x8
C150708	150x70x8

C60408	60x40x8
C60508	60x50x8
C60608	60x60x8
C60708	60x70x8

C180408	180x40x8
C180508	180x50x8
C180608	180x60x8
C180708	180x70x8

C80408	80x40x8
C80508	80x50x8
C80608	80x60x8
C80708	80x70x8

C230408	230x40x8
C230508	230x50x8
C230608	230x60x8
C230708	230x70x8

C100408	100x40x8
C100508	100x50x8
C100608	100x60x8
C100708	100x70x8

C260408	260x40x8
C260508	260x50x8
C260608	260x60x8
C260708	260x70x8

C120408	120x40x8
C120508	120x50x8
C120608	120x60x8
C120708	120x70x8

C650408	650x40x8
C650508	650x50x8
C650608	650x60x8
C650708	650x70x8

C130408	130x40x8
C130508	130x50x8
C130608	130x60x8
C130708	130x70x8

C650808	650x80x8
C6501008	650x100x8

Misure speciali su richiesta - Special sizes on request - Sonderabmessungen auf Anfrage - medidas especiales sobre pedido - Специальные размеры под заказ

## COLTELLI RIGATI PER LEGNI MEDIO/TENERI

Corrugated knives for medium/soft wood

Blanketts für Mittleresholz/Weichholz

Cuchillas corrugadas para madera mediana/ blanda

Бланкетные ножи для мягких пород древесины

# HP

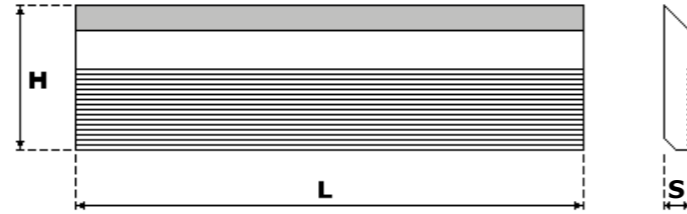

Sp. 8mm / Thick 8mm

CODICE	MISURA (LxHxS) mm	CODICE	MISURA (LxHxS) mm
HP40408	40x40x8	HP150408	150x40x8
HP40508	40x50x8	HP150508	150x50x8
HP40608	40x60x8	HP150608	150x60x8
HP40708	40x70x8	HP150708	150x70x8
HP60408	60x40x8	HP180408	180x40x8
HP60508	60x50x8	HP180508	180x50x8
HP60608	60x60x8	HP180608	180x60x8
HP60708	60x70x8	HP180708	180x70x8
HP80408	80x40x8	HP230408	230x40x8
HP80508	80x50x8	HP230508	230x50x8
HP80608	80x60x8	HP230608	230x60x8
HP80708	80x70x8	HP230708	230x70x8
HP100408	100x40x8	HP260408	260x40x8
HP100508	100x50x8	HP260508	260x50x8
HP100608	100x60x8	HP260608	260x60x8
HP100708	100x70x8	HP260708	260x70x8
HP120408	120x40x8	HP650408	650x40x8
HP120508	120x50x8	HP650508	650x50x8
HP120608	120x60x8	HP650608	650x60x8
HP120708	120x70x8	HP650708	650x70x8
HP130408	130x40x8	HP650808	650x80x8
HP130508	130x50x8	HP6501008	650x100x8
HP130608	130x60x8		
HP130708	130x70x8		

## COLTELLI RIGATI UNIVERSALI

Corrugated knives universal quality

Blanketts universelle Qualität

Cuchillas corrugadas calidad universal

Бланкетные ножи универсальное качество

# HSS

## GREEN LINE

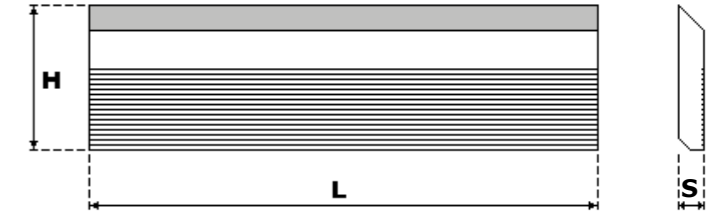

CODICE	MISURA (LxHxS) mm	CODICE	MISURA (LxHxS) mm
HGL40408	40x40x8	HGL150408	150x40x8
HGL40508	40x50x8	HGL150508	150x50x8
HGL40608	40x60x8	HGL150608	150x60x8
HGL40708	40x70x8	HGL150708	150x70x8
HGL60408	60x40x8	HGL180408	180x40x8
HGL60508	60x50x8	HGL180508	180x50x8
HGL60608	60x60x8	HGL180608	180x60x8
HGL60708	60x70x8	HGL180708	180x70x8
HGL80408	80x40x8	HGL230408	230x40x8
HGL80508	80x50x8	HGL230508	230x50x8
HGL80608	80x60x8	HGL230608	230x60x8
HGL80708	80x70x8	HGL230708	230x70x8
HGL100408	100x40x8	HGL260408	260x40x8
HGL100508	100x50x8	HGL260508	260x50x8
HGL100608	100x60x8	HGL260608	260x60x8
HGL100708	100x70x8	HGL260708	260x70x8
HGL120408	120x40x8	HGL650408	650x40x8
HGL120508	120x50x8	HGL650508	650x50x8
HGL120608	120x60x8	HGL650608	650x60x8
HGL120708	120x70x8	HGL650708	650x70x8
HGL130408	130x40x8		
HGL130508	130x50x8		
HGL130608	130x60x8		
HGL130708	130x70x8		

## COLTELLI RIGATI

Corrugated knives

Blanketts

Cuchillas corrugadas

Бланкетные ножи

## HSS TOP LINE

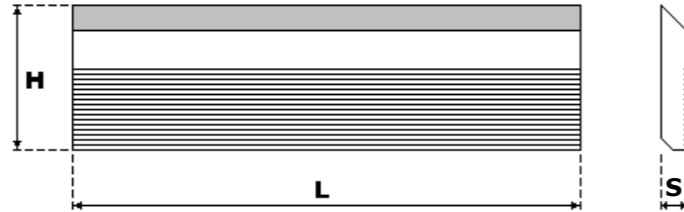

### Sp. 8mm / Thick 8mm

CODICE	MISURA (LxHxS) mm	CODICE	MISURA (LxHxS) mm
H40408	40x40x8	H150408	150x40x8
H40508	40x50x8	H150508	150x50x8
H40608	40x60x8	H150608	150x60x8
H40708	40x70x8	H150708	150x70x8

H60408	60x40x8	H180408	180x40x8
H60508	60x50x8	H180508	180x50x8
H60608	60x60x8	H180608	180x60x8
H60708	60x70x8	H180708	180x70x8

H80408	80x40x8	H230408	230x40x8
H80508	80x50x8	H230508	230x50x8
H80608	80x60x8	H230608	230x60x8
H80708	80x70x8	H230708	230x70x8

H100408	100x40x8	H260408	260x40x8
H100508	100x50x8	H260508	260x50x8
H100608	100x60x8	H260608	260x60x8
H100708	100x70x8	H260708	260x70x8

H120408	120x40x8	H650408	650x40x8
H120508	120x50x8	H650508	650x50x8
H120608	120x60x8	H650608	650x60x8
H120708	120x70x8	H650708	650x70x8

H130408	130x40x8	H650808	650x80x8
H130508	130x50x8	H6501008	650x100x8
H130608	130x60x8		
H130708	130x70x8		

### Sp. 4mm / Thick 4mm

CODICE	MISURA (LxHxS) mm
H650304	650x30x4
H650354	650x35x4
H650404	650x40x4
H650454	650x45x4

### Sp. 5mm / Thick 5mm

CODICE	MISURA (LxHxS) mm
H650405	650x40x5
H650505	650x50x5
H650605	650x60x5

### Sp. 6mm / Thick 6mm

CODICE	MISURA (LxHxS) mm
H650406	650x40x6
H650506	650x50x6
H650606	650x60x6
H650706	650x70x6

### Sp. 10mm / Thick 10mm

CODICE	MISURA (LxHxS) mm
H650410	650x40x10
H650510	650x50x10
H650610	650x60x10
H650710	650x70x10

Lunghezze inferiori ai 650mm aumento 15%  
 Lengths under 650mm, 15% of rise in price  
 Für kürzere Längen von 650 mm - 15% erhöht  
 Largo menos de 650 mm aumento de 15%  
 Стандартная длина 650 мм, при заказе большей  
 или меньшей длины цена увеличивается на 15%

Misure speciali su richiesta - Special sizes on request - Sonderabmessungen auf Anfrage - medidas especiales sobre pedido - Специальные размеры под заказ

## COLTELLI RIGATI RIVESTITI

Coated corrugated knives

Beschichte Blanketts

Cuchillas corrugadas recubiertas

Бланкетные ножи специальное покрытие

## RADIS LINE High quality performance

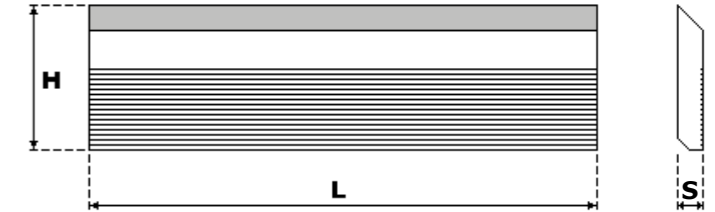

CODICE	MISURA (LxHxS) mm
RD40408	40x40x8
RD40508	40x50x8
RD40608	40x60x8
RD40708	40x70x8

RD60408	60x40x8
RD60508	60x50x8
RD60608	60x60x8
RD60708	60x70x8

RD80408	80x40x8
RD80508	80x50x8
RD80608	80x60x8
RD80708	80x70x8

RD100408	100x40x8
RD100508	100x50x8
RD100608	100x60x8
RD100708	100x70x8

RD120408	120x40x8
RD120508	120x50x8
RD120608	120x60x8
RD120708	120x70x8

RD130408	130x40x8
RD130508	130x50x8
RD130608	130x60x8
RD130708	130x70x8

CODICE	MISURA (LxHxS) mm
RD150408	150x40x8
RD150508	150x50x8
RD150608	150x60x8
RD150708	150x70x8

RD180408	180x40x8
RD180508	180x50x8
RD180608	180x60x8
RD180708	180x70x8

RD230408	230x40x8
RD230508	230x50x8
RD230608	230x60x8
RD230708	230x70x8

RD260408	260x40x8
RD260508	260x50x8
RD260608	260x60x8
RD260708	260x70x8

RD650408	650x40x8
RD650508	650x50x8
RD650608	650x60x8
RD650708	650x70x8
RD650808	650x80x8

Misure speciali su richiesta - Special sizes on request - Sonderabmessungen auf Anfrage - medidas especiales sobre pedido - Специальные размеры под заказ

## COLTELLI RIGATI

Corrugated knives

Blanketts

Cuchillas corrugadas

Бланкетные ножи

## HM

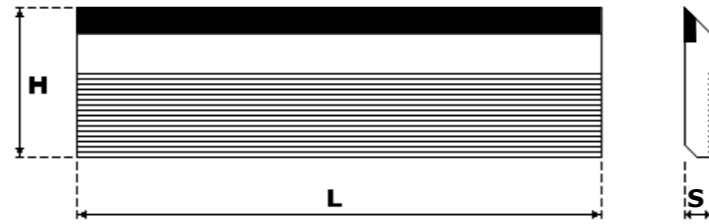

CODICE	MISURA (LxHxS) mm	HM
HM40408	40x40x8-10	15x2
HM40508	40x50x8-10	20x2
HM40608	40x60x8-10	25x2
HM40708	40x70x8-10	30x2
HM60408	60x40x8-10	15x2
HM60508	60x50x8-10	20x2
HM60608	60x60x8-10	25x2
HM60708	60x70x8-10	30x2
HM80408	80x40x8-10	15x2
HM80508	80x50x8-10	20x2
HM80608	80x60x8-10	25x2
HM80708	80x70x8-10	30x2
HM100408	100x40x8-10	15x2
HM100508	100x50x8-10	20x2
HM100608	100x60x8-10	25x2
HM100708	100x70x8-10	30x2
HM120408	120x40x8-10	15x2
HM120508	120x50x8-10	20x2
HM120608	120x60x8-10	25x2
HM120708	120x70x8-10	30x2

CODICE	MISURA (LxHxS) mm	HM
HM130408	130x40x8-10	15x2
HM130508	130x50x8-10	20x2
HM130608	130x60x8-10	25x2
HM130708	130x70x8-10	30x2
HM150408	150x40x8-10	15x2
HM150508	150x50x8-10	20x2
HM150608	150x60x8-10	25x2
HM150708	150x70x8-10	30x2
HM180408	180x40x8-10	15x2
HM180508	180x50x8-10	20x2
HM180608	180x60x8-10	25x2
HM180708	180x70x8-10	30x2
HM230408	230x40x8-10	15x2
HM230508	230x50x8-10	20x2
HM230608	230x60x8-10	25x2
HM230708	230x70x8-10	30x2
HM650408	650x40x8-10	15x2
HM650508	650x50x8-10	20x2
HM650608	650x60x8-10	25x2
HM650708	650x70x8-10	30x2

## COLTELLI RIGATI

Corrugated knives

Blanketts

Cuchillas corrugadas

Бланкетные ножи

## DUPLEX SYSTEM

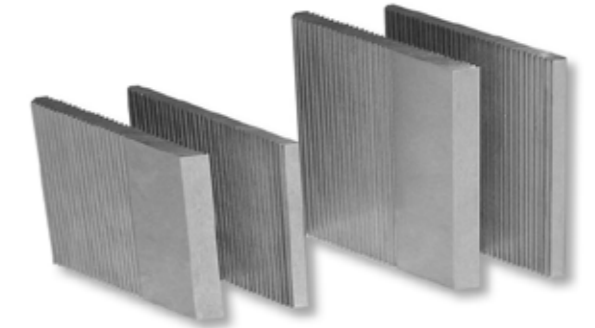

CODICE	MISURA (mm)
DSK404010	40x40x10
DSK504010	50x40x10
DSK604010	60x40x10
DSK804010	80x40x10
DSK1004010	100x40x10
DSK1204010	120x40x10
DSK1304010	130x40x10
DSK1504010	150x40x10
DSK1704010	170x40x10
DSK1804010	180x40x10
DSK2004010	200x40x10
DSK2104010	210x40x10
DSK2304010	230x40x10
DSK3104010	310x40x10
DSK3304010	330x40x10
DSK405010	40x50x10
DSK505010	50x50x10
DSK605010	60x50x10
DSK805010	80x50x10
DSK1005010	100x50x10
DSK1205010	120x50x10
DSK1305010	130x50x10
DSK1505010	150x50x10
DSK1705010	170x50x10
DSK1805010	180x50x10
DSK2005010	200x50x10
DSK2105010	210x50x10
DSK2305010	230x50x10
DSK3105010	310x50x10
DSK3305010	330x50x10

CODICE	MISURA (mm)
DSK406010	40x60x10
DSK506010	50x60x10
DSK606010	60x60x10
DSK806010	80x60x10
DSK1006010	100x60x10
DSK1206010	120x60x10
DSK1306010	130x60x10
DSK1506010	150x60x10
DSK1706010	170x60x10
DSK1806010	180x60x10
DSK2006010	200x60x10
DSK2106010	210x60x10
DSK2306010	230x60x10
DSK3106010	310x60x10
DSK3306010	330x60x10



## METALLO DURO

Carbide

Hart metall

Metal durox

Твердые металлы

## DUPLEX SYSTEM



CODICE	MISURA (mm)	CODICE	MISURA (mm)
HM40383	40x38x3	HM40603	40x60x3
HM50383	50x38x3	HM50603	50x60x3
HM60383	60x38x3	HM60603	60x60x3
HM80383	80x38x3	HM80603	80x60x3
HM100383	100x38x3	HM100603	100x60x3
HM120383	120x38x3	HM120603	120x60x3
HM130383	130x38x3	HM130603	130x60x3
HM150383	150x38x3	HM150603	150x60x3
HM170383	170x38x3	HM170603	170x60x3
HM180383	180x38x3	HM180603	180x60x3
HM200383	200x38x3	HM200603	200x60x3
HM210383	210x38x3	HM210603	210x60x3
HM230383	230x38x3	HM230603	230x60x3
HM310383	310x38x3	HM310603	310x60x3
HM330383	330x38x3	HM330603	330x60x3
HM40503	40x50x3		
HM50503	50x50x3		
HM60503	60x50x3		
HM80503	80x50x3		
HM100503	100x50x3		
HM120503	120x50x3		
HM130503	130x50x3		
HM150503	150x50x3		
HM170503	170x50x3		
HM180503	180x50x3		
HM200503	200x50x3		
HM210503	210x50x3		
HM230503	230x50x3		
HM310503	310x50x3		
HM330503	330x50x3		

## COLTELLI REVERSIBILI - Caratteristiche del grano e applicazioni

Reversible knives - grain size definition and applications

Wendeschneidplatten - Korngrößendefinition und Anwendungen

Aplicaciones Cuchillas reversibles - tamaño del grano y aplicaciones

Сменные ножи - характеристики зерна и область применения

Grado ILMA	Dimesioni del grano	HRC	Tenacità	Resistenza flessionale
ILMA Grade	Grain size		Toughness	Bending Strenght
SM.01-4.HMT	Micro 0,7-1,0 µm	84	*	*
F.01-4.T	Fine 1,0-1,4 µm	81	**	*
M.30-2.DT	Medium/Fine 1,4-2,5 µm	78	***	**
F.10/40-3.DT	Micro 0,7-1,0 µm	79	**	***

Grado ILMA	Codice	Legno tenero	Legno duro	Truciolare	MDF	HDF	Plastica
ILMA Grade	Code	Softwood	Hardwood	Chipboard			Plastic
SM.01-4.HMT	20			*	***	**	***
F.01-4.T	40	**	**	**	**	*	**
M.30-2.DT	80	**	**	**			
F.10/40-3.DT	90	**	**	**			

\* Buono - Good - Gute Qualität - Bueno - Хорошего качества

\*\* Molto buono - Very good - Sehr gute Qualität - Muy bueno - Очень хорошего качества

\*\*\* Ottimo - Excellent - Ausgezeichnete Qualität - Excelente - Отличного качества

## COLTELLI REVERSIBILI STANDARD

Reversible knives

Wendeschneidplatten

Cuchillas reversibles

Сменные твердосплавные ножи стандарт

## HW 35° Z=2

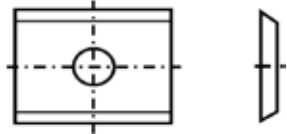
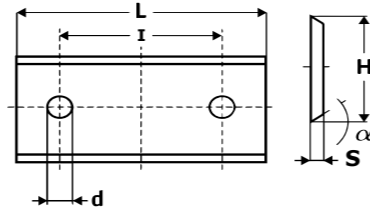

L	H	S	I	F.01-4.T	SM.01-4.HMT	M.30-2.DT	F.10/40.3.DT
7.5	12.0	1.5		01.40.751215			01.90.751215
8.6	12.0	1.5		01.40.861215			
9.0	12.0	1.5		01.40.901215			
9.6	12.0	1.5		01.40.961215			01.90.961215
10.0	12.0	1.5		01.40.101215			
10.5	12.0	1.5		01.40.1051215			
11.0	12.0	1.5		01.40.111215			
11.6	12.0	1.5		01.40.1161215			
13.0	12.0	1.5		01.40.131215			
13.6	12.0	1.5		01.40.1361215			
14.6	12.0	1.5		01.40.1461215			
15.0	12.0	1.5		01.40.151215	01.20.151215		01.90.151215
15.7	12.0	1.5		01.40.1571215			
16.0	12.0	1.5		01.40.161215			
17.0	12.0	1.5		01.40.171215			
18.0	12.0	1.5		01.40.181215			
19.0	12.0	1.5		01.40.191215			
20.0	12.0	1.5		01.40.201215	01.20.201215		01.90.201215
25.0	12.0	1.5		01.40.251215			01.90.251215

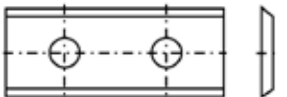

L	H	S	I	F.01-4.T	SM.01-4.HMT	F.10/40.3.DT
25.0	12.0	1.5	14.0	01.40.251215.2F		01.90.251215
30.0	12.0	1.5	14.0	01.40.301215	01.20.301215	01.90.301215
35.0	12.0	1.5	26.0	01.40.351215		
40.0	12.0	1.5	26.0	01.40.401215	01.20.401215	01.90.401215
50.0	12.0	1.5	26.0	01.40.501215	01.20.501215	01.90.501215
60.0	12.0	1.5	26.0	01.40.601215	01.20.601215	01.90.601215



L	H	S	I	M.30-2.DT	F.10/40.3.DT
80.0	13.0	2.2	60.0	01.80.801322	01.90.801322
100.0	13.0	2.2	60.0	01.80.1001322	01.90.1001322
120.0	13.0	2.2	60.0	01.80.1201322	01.90.1201322

## COLTELLI REVERSIBILI STANDARD PER TESTE PIALLA

Reversible knives for planer heads

Wendeschneidplatten Für Hobelköpfe

Cuchillas reversibles para portacuchillas de cepillo

Сменные ножи стандарт для строгальных головок

## HW Z=2

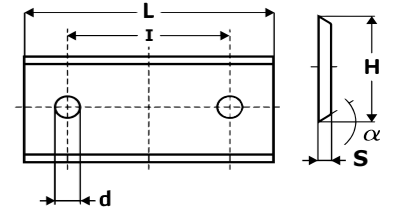

L	H	S	alpha	F.01-4.T	SM.01-4.HMT	M.30-2.DT	F.10/40-3.DT
20.0	12.0	1.5	35°				02.90.201215
20.0	12.0	1.5	45°				02.90.201215/45
24.0	12.0	1.5	40°	02.40.241215/40			02.90.241215/40
24.7	12.0	1.5	35°	02.40.2471215			02.50.2471215

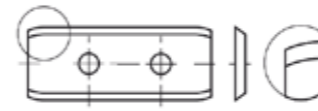

L	H	S	alpha	F.01-4.T	SM.01-4.HMT	M.30-2.DT	F.10/40-3.DT
30.0	12.0	1.5	35°	02.40.301215			02.90.301215
50.0	12.0	1.5	35°				02.90.501215

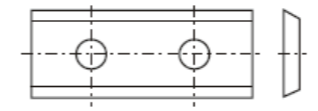

L	H	S	alpha	F.01-4.T	SM.01-4.HMT	M.30-2.DT	F.10/40-3.DT
30.0	12.0	2.5	35°	02.40.301225			

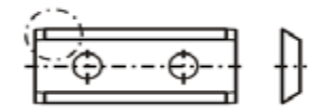

L	H	S	alpha	F.01-4.T	SM.01-4.HMT	M.30-2.DT	F.10/40-3.DT
30.0	12.0	2.5	35°			02.80.301225	

## COLTELLI REVERSIBILI STANDARD

Reversible knives

Wendeschneidplatten

Cuchillas reversibles

Сменные твердосплавные ножи

## HW 45°

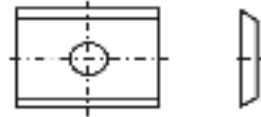
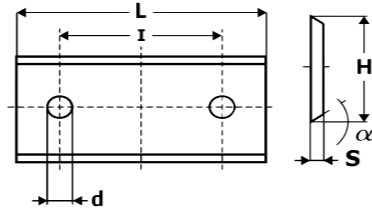

L	H	S	I	F.01-4.T	SM.01-4.HMT	M.30-2.DT	F.10/40-3.DT
mm	mm	mm	mm				
7.5	12.0	1.5					06.80.751215
9.6	12.0	1.5					06.80.961215
15.0	12.0	1.5					06.80.151215
20.0	12.0	1.5					06.80.201215
25.0	12.0	1.5					06.80.251215

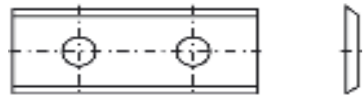

L	H	S	I	F.01-4.T	SM.01-4.HMT	M.30-2.DT	F.10/40-3.DT
mm	mm	mm	mm				
25.0	12.0	1.5	14				06.90.251215
30.0	12.0	1.5	14				06.90.301215
40.0	12.0	1.5	26				06.90.401215
50.0	12.0	1.5	26				06.90.501215
60.0	12.0	1.5	26				06.90.601215
25.0	12.0	1.5					06.80.251215

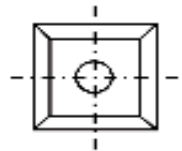

L	H	S	I	F.01-4.T	SM.01-4.HMT	M.30-2.DT	F.10/40-3.DT
mm	mm	mm	mm				
12.0	12.0	1.5					06.90.121215

## COLTELLI REVERSIBILI

Reversible knives

Wendeschneidplatten

Cuchillas reversibles

Сменные твердосплавные ножи

## HW Z=4

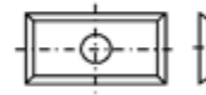
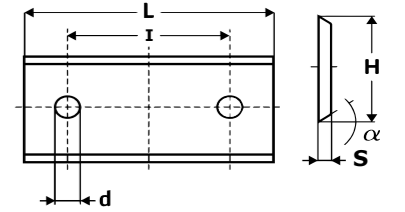

L	H	S	I	F.01-4.T	SM.01-4.HMT	M.30-2.DT	F.10/40-3.DT
mm	mm	mm	mm				
19.5	7.0	1.5		03.04.195715			
19.5	7.5	1.5		03.04.1957515			
19.5	8.0	1.5		03.04.195815			
19.5	9.0	1.5		03.04.195915			
19.5	10.0	1.5		03.04.1951015			
19.5	11.0	1.5		03.04.1951115			
19.5	12.0	1.5		03.04.1951215	03.20.1951215		

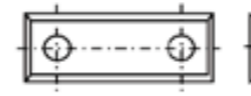

L	H	S	I	F.01-4.T	SM.01-4.HMT	M.30-2.DT	F.10/40-3.DT
mm	mm	mm	mm				
29.5	7.0	1.5	14.0	03.04.295715			
29.5	7.5	1.5	14.0	03.04.2957515			
29.5	8.0	1.5	14.0	03.04.295815			
29.5	9.0	1.5	14.0	03.04.295915	03.20.295915		
29.5	10.0	1.5	14.0	03.04.2951015			
29.5	11.0	1.5	14.0	03.04.2951115			
29.5	12.0	1.5	14.0	03.04.2951215	03.20.2951215		03.90.4951215

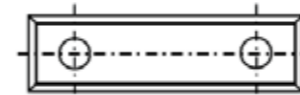

L	H	S	I	F.01-4.T	SM.01-4.HMT	M.30-2.DT	F.10/40-3.DT
mm	mm	mm	mm				
39.5	9.0	1.5	26.0	03.04.395915	03.20.395915		03.90.395915
39.5	12.0	1.5	26.0	03.04.3951215	03.20.3951215		03.90.3951215

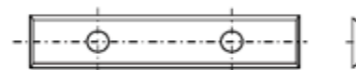

L	H	S	I	F.01-4.T	SM.01-4.HMT	M.30-2.DT	F.10/40-3.DT
mm	mm	mm	mm				
49.5	8.0	1.5	26.0	03.04.495815			
49.5	9.0	1.5	26.0	03.04.495915	03.20.495915		
49.5	10.0	1.5	26.0	03.04.4951015			
49.5	12.0	1.5	26.0	03.04.4951215	03.20.4951215		03.90.4951215
59.5	12.0	1.5	26.0	03.04.5951215			



L	H	S	I	F.01-4.T	SM.01-4.HMT	M.30-2.DT	F.10/40-3.DT
mm	mm	mm	mm				
50.0	9.0	1.5	37.0	03.04.50915			
50.0	12.0	1.7	37.0	03.04.501217	03.20.501217		03.90.501217

## COLTELLI REVERSIBILI

Reversible knives

Wendeschneidplatten

Cuchillas reversibles

Сменные твердосплавные ножи

## HW Z=4

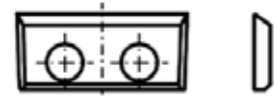
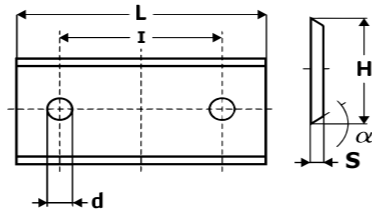

L	H	S	I	F.01-4.T	SM.01-4.HMT	M.30-2.DT	F.10/40-3.DT
mm	mm	mm	mm				
16.0	7.0	1.5	7.0	03.04.16715			

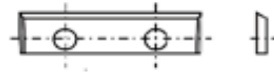

L	H	S	I	F.01-4.T	SM.01-4.HMT	M.30-2.DT	F.10/40-3.DT
mm	mm	mm	mm				
23.0	7.0	1.5	14.0	03.04.23715			
28.0	7.0	1.5	14.0	03.04.28715	03.20.28715		



L	H	S	I	F.01-4.T	SM.01-4.HMT	M.30-2.DT	F.10/40-3.DT
mm	mm	mm	mm				
16.0	7.0	1.5	7.0	03.04.16715-1			

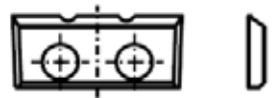

L	H	S	I	F.01-4.T	SM.01-4.HMT	M.30-2.DT	F.10/40-3.DT
mm	mm	mm	mm				
16.0	7.0	1.5	7.0	03.04.16715-2			
23.0	7.0	1.5	14.0	03.04.23715-2			



L	H	S	I	F.01-4.T	SM.01-4.HMT	M.30-2.DT	F.10/40-3.DT
mm	mm	mm	mm				
23.0	7.0	1.5	14.0	03.04.23715-3			

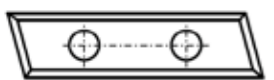

L	H	S	I	F.01-4.T	SM.01-4.HMT	M.30-2.DT	F.10/40-3.DT
mm	mm	mm	mm				
31.5	9.0	1.5	14.0	03.04.315915			

## COLTELLI REVERSIBILI QUADRATI

Square knives

Quadratische Wendeschneidplatten

Cuchillas reversibles cuadradas

Сменные квадратные ножи

## HW

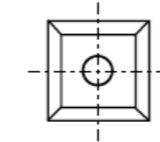
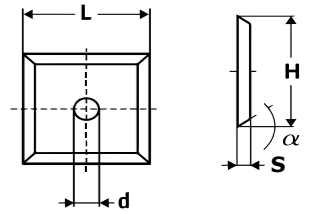

L	H	S	d	F.01-4.T	SM.01-4.HMT	M.30-2.DT	F.10/40-3.DT
mm	mm	mm	mm				
9.0	9.0	1.5	4	35°	04.40.9915		
10.5	10.5	1.5	4	35°	04.40.10510515		
12.0	12.0	1.5	4	35°	04.40.1215	04.20.1215	04.90.1215
13.0	13.0	2.5	4	35°	04.40.131325		
17.0	17.0	2.0	3	35°	04.40.172-F3		04.80.172-F3
17.0	17.0	2.0	4	35°	04.40.172		04.0.172
19.0	19.0	2.0	4	35°	04.40.19192		

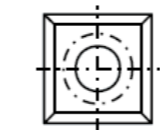

L	H	S	d	F.01-4.T	SM.01-4.HMT	M.30-2.DT	F.10/40-3.DT
mm	mm	mm	mm				
13.0	13.0	2.5	30°			04.80.1325/30	
13.6	13.6	2.0	30°			04.80.1362/30	
13.6	13.6	2.0	45°			04.80.1362/45	
14.0	14.0	1.2	30°			04.80.1412/30	
14.0	14.0	1.7	22°			04.80.1417/22	
14.0	14.0	1.7	30°			04.80.147/30	
14.0	14.0	2.0	30°	04.40.142/30	04.20.142/30	04.80.142/30	04.90.142/30

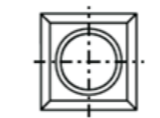

For Holz-Her system

L	H	S	d	M.30-2.DT
mm	mm	mm	mm	
14.0	14.0	1.2	30°	04.80.1412-HHS

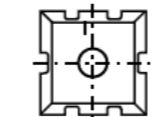

L	H	S	d	M.30-2.DT
mm	mm	mm	mm	
15.0	15.0	2.0		04.80.152

## COLTELLI REVERSIBILI QUADRATI PER TESTE PIALLA

Square knives for planer heads

Quadratische Wendeschneidplatten für Hobelköpfe

Cuchillas reversibles cuadradas para portacuchillas de cepillo

Сменные квадратные ножи для строгальных головок

# HW

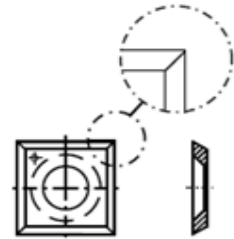
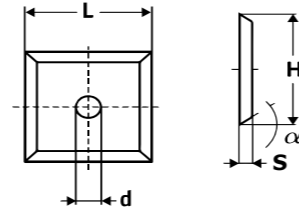

L	H	S					
mm	mm	mm		F.01-4.T	SM.01-4.HMT	M.30-2.DT	F.10/40-3.DT
10.5	10.5	1.5	35°				
14.0	14.0	2.0	30°	07.40.142/30D		07.80.142/30D	07.90.142/30D
14.0	14.0	2.0	37°			07.80.142/37D	07.90.142/37D
14.3	14.3	2.5	35°				07.90.14325/35D
14.6	14.6	2.5	30°				07.90.14625/30D
15.0	15.0	2.5	30°				07.90.1525/30D
15.0	15.0	2.5	37°				07.90.1525/37D

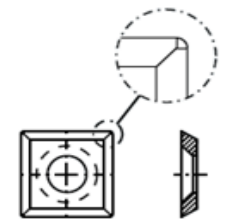

L	H	S					
mm	mm	mm		F.01-4.T	SM.01-4.HMT	M.30-2.DT	F.10/40-3.DT
14.0	14.0	2.0	30°			07.80.142/30R	07.90.142/30R
14.6	14.6	2.5	30°				07.90.14625/30R
15.0	15.0	2.5	30°				07.90.1525/30R
15.0	15.0	2.5	37°				07.90.1525/37R

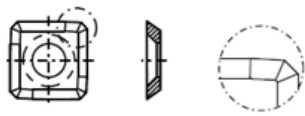

For Ledinek system - left/right

L	H	S					
mm	mm	mm		F.01-4.T	SM.01-4.HMT	M.30-2.DT	F.10/40-3.DT
14.3	14.3	2.5	35°				07.90.14325-LS/L
14.3	14.3	2.5	35°				07.90.14325-LS/R

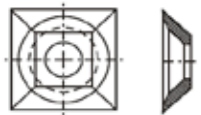

L	H	S					
mm	mm	mm		F.01-4.T	SM.01-4.HMT	M.30-2.DT	F.10/40-3.DT
21.0	21.0	5.5	40°	04.90.2155			07.90.2155

## COLTELLI REVERSIBILI QUADRATI PER TESTE PIALLA

Square knives for planer heads

Quadratische Wendeschneidplatten für Hobelköpfe

Cuchillas reversibles cuadradas para portacuchillas de cepillo

Сменные квадратные ножи для строгальных головок

# HW

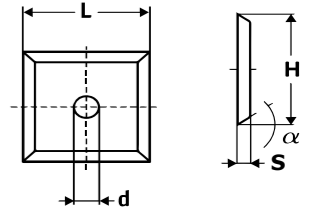

L	H	S						
mm	mm	mm	R		F.01-4.T	SM.01-4.HMT	M.30-2.DT	F.10/40-3.DT
15.0	15.0	2.5	150	30°				08.90.1525RR150
15.0	15.0	2.5	115	30°				08.90.1525RR115



L	H	S						
mm	mm	mm	R		F.01-4.T	SM.01-4.HMT	M.30-2.DT	F.10/40-3.DT
14.0	14.0	2.0	150	30°				08.90.142RR150
14.6	14.6	2.5	150	30°				08.90.14625RR150
15.0	15.0	2.5	50	30°				08.90.1525RR50
15.0	15.0	2.5	180	30°				08.90.1525RR180
15.0	15.0	2.5	200	30°				08.90.1525RR200

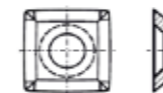

L	H	S						
mm	mm	mm	R		F.01-4.T	SM.01-4.HMT	M.30-2.DT	F.10/40-3.DT
15.0	15.0	2.5	170	40				08.90.1525R170

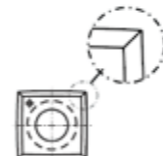

L	H	S						
mm	mm	mm	R		F.01-4.T	SM.01-4.HMT	M.30-2.DT	F.10/40-3.DT
15.0	15.0	2.5	150	30°				08.90.1525R150
15.0	15.0	2.5	100	30°				08.90.1525R100

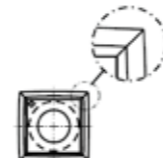

L	H	S						
mm	mm	mm	R		F.01-4.T	SM.01-4.HMT	M.30-2.DT	F.10/40-3.DT
14.0	14.0	2.0	150	30°				08.90.142R150
14.6	14.6	2.5	150	30°				08.90.14625R150
15.0	15.0	2.5	50	30°				08.90.1525R50

## COLTELLI REVERSIBILI SPECIALI

Special reversible knives

Spezial-wendeschneidplatten

Cuchillas reversible especial

Сменные твердосплавные специальные ножи

# HW

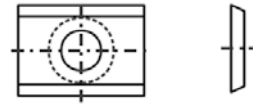
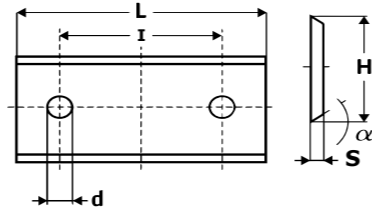

L	H	S	I	F-01-4.T	SM.01-4.MT	M.30-2.DT	F.10/40.3.DT
mm	mm	mm	mm				
20.0	14.3	2.5		05.40.2014325-A			

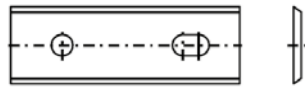

L	H	S	I	F-01-4.T	SM.01-4.MT	M.30-2.DT	F.10/40.3.DT
mm	mm	mm	mm				
44.5	15.0	1.5	25.0	05.40.4451515-B			

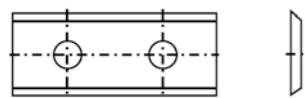

L	H	S	I	F-01-4.T	SM.01-4.MT	M.30-2.DT	F.10/40.3.DT
mm	mm	mm	mm				
30.0	12.0	1.5	16.0	05.40.301215-C			



L	H	S	I	F-01-4.T	SM.01-4.MT	M.30-2.DT	F.10/40.3.DT
mm	mm	mm	mm				
24.0	12.0	1.5		0540.241215-D			

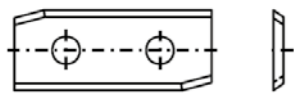

L	H	S	I	F-01-4.T	SM.01-4.MT	M.30-2.DT	F.10/40.3.DT
mm	mm	mm	mm				
30.0	12.0	1.5	14.0	05.40.301215-E			
50.0	12.0	1.5	26.0	05.40.501215-E			

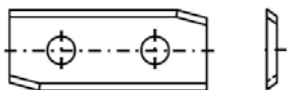

L	H	S	I	F-01-4.T	SM.01-4.MT	M.30-2.DT	F.10/40.3.DT
mm	mm	mm	mm				
30.0	12.0	1.5	14.0	05.40.301215-F			
50.0	12.0	1.5	26.0	05.40.501215-F			

## COLTELLI REVERSIBILI SPECIALI

Special reversible knives

Spezial-wendeschneidplatten

Cuchillas reversible especial

Сменные твердосплавные специальные ножи

# HW

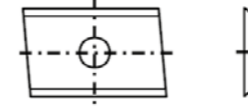
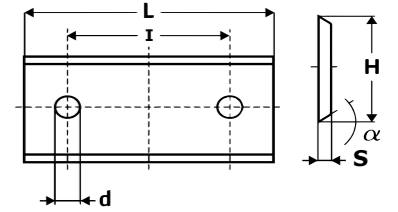

L	H	S	I	F-01-4.T	SM.01-4.MT	M.30-2.DT	F.10/40.3.DT
mm	mm	mm	mm				
20.0	12.0	1.5		05.40.201215-G			

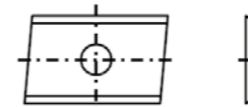

L	H	S	I	F-01-4.T	SM.01-4.MT	M.30-2.DT	F.10/40.3.DT
mm	mm	mm	mm				
20.0	12.0	1.5		05.40.201215-H			

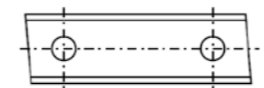

L	H	S	I	Codice	F-01-4.T	SM.01-4.MT	M.30-2.DT	F.10/40.3.DT
mm	mm	mm	mm					
30.0	12.0		14.0	05.40.301215-I				
40.0	12.0		26.0	05.40.401215-I				
50.0	12.0	1.5	26.0	05.40.501215-I				

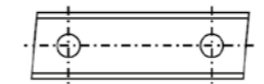

L	H	S	I	Codice	F-01-4.T	SM.01-4.MT	M.30-2.DT	F.10/40.3.DT
mm	mm	mm	mm					
30.0	12.0		14.0	05.40.301215-L				
40.0	12.0		26.0	05.40.401215-L				
50.0	12.0	1.5	26.0	05.40.501215-L				

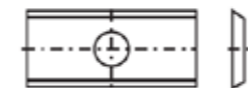

L	H	S	I	Codice	F-01-4.T	SM.01-4.MT	M.30-2.DT	F.10/40.3.DT
mm	mm	mm	mm					
20.0	9.0	1.5		05.40.20915-M				



L	H	S	I	Codice	F-01-4.T	SM.01-4.MT	M.30-2.DT	F.10/40.3.DT
mm	mm	mm	mm					
24.0	9.0	1.5	14.0	05.40.24915-N				
30.0	9.0	1.5	14.0	05.40.30915-N				
40.0	9.0	1.5	26.0	05.40.40915-N				

## RASANTI, COLTELLI PER SCANALATURA

Spurs, grooving knives

Vorschneider, Nuter

Incisores, cuchillas para ranura

Твердосплавные ножи для формирования пазов

# HM

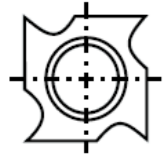

L	H	S					
mm	mm	mm		F.01-4.T	SM.01-4.HMT	M.30-2.DT	F.10/40-3.DT
18.0	18.0	1.95				09.80.1818195	
18.0	18.0	2.45				09.80.1818245	
18.0	18.0	2.95				09.80.1818295	
18.0	18.0	3.70				09.80.1818370	



L	H	S	I				
mm	mm	mm	mm	F-01-4.T	SM.01-4.MT	M.30-2.DT	F.10/40.3.DT
22.9	19.8	2.5	30°			09.80.22919825	
22.0	19.0	2.0	30°			09.80.22192	
22.0	22.0	2.0	30°			09.80.22222	



L	H	S	I				
mm	mm	mm	mm	F-01-4.T	SM.01-4.MT	M.30-2.DT	F.10/40.3.DT
14.0	28.0	2.0	30°			09.80.14282	
16.0	16.0	3.0	32°			09.80.16163	

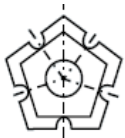

L	H	S	I				
mm	mm	mm	mm	F-01-4.T	SM.01-4.MT	M.30-2.DT	F.10/40.3.DT
18.5		3.25	30°				09.90.185325

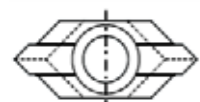

L	H	S	I				
mm	mm	mm	mm	F-01-4.T	SM.01-4.MT	M.30-2.DT	F.10/40.3.DT
18.9	7.9	4.0				09.80.189794	

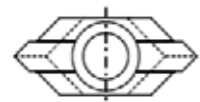

L	H	S	I				
mm	mm	mm	mm	F-01-4.T	SM.01-4.MT	M.30-2.DT	F.10/40.3.DT
18.0	5.7	3.5		09.40.185735			

## TESTE PORTACOLTELLI PIALLA IN LEGA LEGGERA

Alluminium cutter heads for planer knives

Köpfe leichtmetall für hobelmesser

Cabezales portacuchillas de cepillo en aluminio

Дюралевые ножевые барабаны для плоского строгания

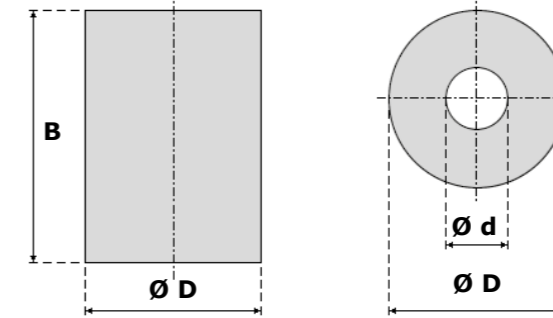

CODICE	Ø D (mm)	B (mm)	Ø d (mm)	Z	CODICE	Ø D (mm)	B (mm)	Ø d (mm)	Z
TPL125604	125	60	40	4	TPL125606	125	60	40	6
TPL125804	125	80	40	4	TPL125806	125	80	40	6
TPL1251004	125	100	40	4	TPL1251006	125	100	40	6
TPL1251204	125	120	40	4	TPL1251206	125	120	40	6
TPL1251304	125	130	40	4	TPL1251306	125	130	40	6
TPL1251504	125	150	40	4	TPL1251506	125	150	40	6
TPL1251604	125	160	40	4	TPL1251606	125	160	40	6
TPL1251804	125	180	40	4	TPL1251806	125	180	40	6
TPL1251904	125	190	40	4	TPL1251906	125	190	40	6
TPL1252004	125	200	40	4	TPL1252006	125	200	40	6
TPL1252204	125	220	40	4	TPL1252206	125	220	40	6
TPL1252304	125	230	40	4	TPL1252306	125	230	40	6
TPL1252404	125	240	40	4	TPL1252406	125	240	40	6
TPL1252504	125	250	40	4	TPL1252506	125	250	40	6
TPL1252604	125	260	40	4	TPL1252606	125	260	40	6
TPL140604	140	60	40	4	TPL140606	140	60	40	6
TPL140804	140	80	40	4	TPL140806	140	80	40	6
TPL1401004	140	100	40	4	TPL1401006	140	100	40	6
TPL1401204	140	120	40	4	TPL1401206	140	120	40	6
TPL1401304	140	130	40	4	TPL1401306	140	130	40	6
TPL1401504	140	150	40	4	TPL1401506	140	150	40	6
TPL1401604	140	160	40	4	TPL1401606	140	160	40	6
TPL1401804	140	180	40	4	TPL1401806	140	180	40	6
TPL1401904	140	190	40	4	TPL1401906	140	190	40	6
TPL1402004	140	200	40	4	TPL1402006	140	200	40	6
TPL1402204	140	220	40	4	TPL1402206	140	220	40	6
TPL1402304	140	230	40	4	TPL1402306	140	230	40	6
TPL1402404	140	240	40	4	TPL1402406	140	240	40	6
TPL1402504	140	250	40	4	TPL1402506	140	250	40	6
TPL1402604	140	260	40	4	TPL1402606	140	260	40	6

## TESTE PORTACOLTELLI PIALLA ACCIAIO

Steel cutter heads for planer knives

Köpfe zu stahl für hobelmesser

Cabezales portacuchillas de cepillo en acero

Стальные ножевые барабаны для плоского строгания

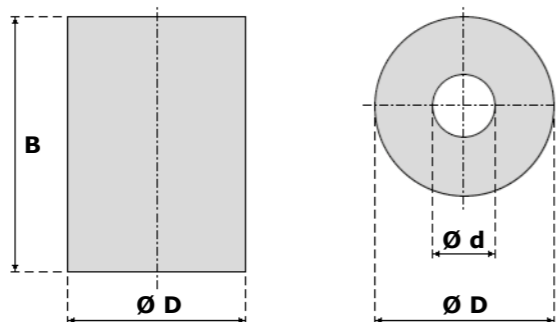

CODICE	Ø D (mm)	B (mm)	Ø d (mm)	Z	CODICE	Ø D (mm)	B (mm)	Ø d (mm)	Z
TPA125604	125	60	40	4	TPA125606	125	60	40	6
TPA125804	125	80	40	4	TPA125806	125	80	40	6
TPA1251004	125	100	40	4	TPA1251006	125	100	40	6
TPA1251204	125	120	40	4	TPA1251206	125	120	40	6
TPA1251304	125	130	40	4	TPA1251306	125	130	40	6
TPA1251504	125	150	40	4	TPA1251506	125	150	40	6
TPA1251604	125	160	40	4	TPA1251606	125	160	40	6
TPA1251804	125	180	40	4	TPA1251806	125	180	40	6
TPA1251904	125	190	40	4	TPA1251906	125	190	40	6
TPA1252004	125	200	40	4	TPA1252006	125	200	40	6
TPA1252204	125	220	40	4	TPA1252206	125	220	40	6
TPA1252304	125	230	40	4	TPA1252306	125	230	40	6
TPA1252404	125	240	40	4	TPA1252406	125	240	40	6
TPA1252504	125	250	40	4	TPA1252506	125	250	40	6
TPA1252604	125	260	40	4	TPA1252606	125	260	40	6
TPA140604	140	60	40	4	TPA140606	140	60	40	6
TPA140804	140	80	40	4	TPA140806	140	80	40	6
TPA1401004	140	100	40	4	TPA1401006	140	100	40	6
TPA1401204	140	120	40	4	TPA1401206	140	120	40	6
TPA1401304	140	130	40	4	TPA1401306	140	130	40	6
TPA1401504	140	150	40	4	TPA1401506	140	150	40	6
TPA1401604	140	160	40	4	TPA1401606	140	160	40	6
TPA1401804	140	180	40	4	TPA1401806	140	180	40	6
TPA1401904	140	190	40	4	TPA1401906	140	190	40	6
TPA1402004	140	200	40	4	TPA1402006	140	200	40	6
TPA1402204	140	220	40	4	TPA1402206	140	220	40	6
TPA1402304	140	230	40	4	TPA1402306	140	230	40	6
TPA1402404	140	240	40	4	TPA1402406	140	240	40	6
TPA1402504	140	250	40	4	TPA1402506	140	250	40	6
TPA1402604	140	260	40	4	TPA1402606	140	260	40	6

Misure speciali su richiesta - Special sizes on request - Sonderabmessungen auf Anfrage - medidas especiales sobre pedido - Специальные размеры под заказ

## TESTE CENTROLOCK LEGA LEGGERA

Cutterheads light alloy for Centrolock knives

Köpfe leichtmetall für Centrolock messer

Cabezales Centrolock en aluminio

Дюралевые барабаны Centrolock

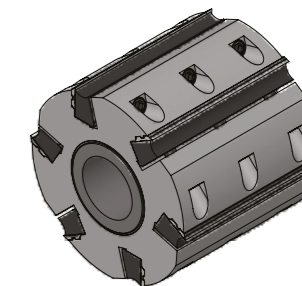

Codice	D	B	d	Z
TCL1001204	100	120	35	4
TCL1001904	100	190	35	4
TCL1251004	125	100	40	4
TCL1251304	125	130	40	4
TCL1251504	125	150	40	4
TCL1251804	125	180	40	4
TCL1252104	125	210	40	4
TCL1252304	125	230	40	4
TCL1252504	125	250	40	4
TCL1401004	140	100	40-50	4
TCL1401304	140	130	40-50	4
TCL1401504	140	150	40-50	4
TCL1401804	140	180	40-50	4
TCL1402104	140	210	40-50	4
TCL1402304	140	230	40-50	4
TCL1402504	140	250	40-50	4
TCL1601006	160	100	40-50	6
TCL1601306	160	130	40-50	6
TCL1601506	160	150	40-50	6
TCL1601806	160	180	40-50	6
TCL1602106	160	210	40-50	6
TCL1602306	160	230	40-50	6
TCL1602506	160	250	40-50	6

Misure speciali su richiesta - Special sizes on request - Sonderabmessungen auf Anfrage - medidas especiales sobre pedido - Специальные размеры под заказ

## TESTA PORTACOLTELLI ELICOIDALE IN LEGA PER PIALLATURA

Alluminium spiral planing cutter heads

Leichtmetall Spiral Hobelmesserkopf

Cabezales portacuchillas para cepillar en aluminio

Барабаны с винтовым расположением ножей предварительного строгания из алюминия

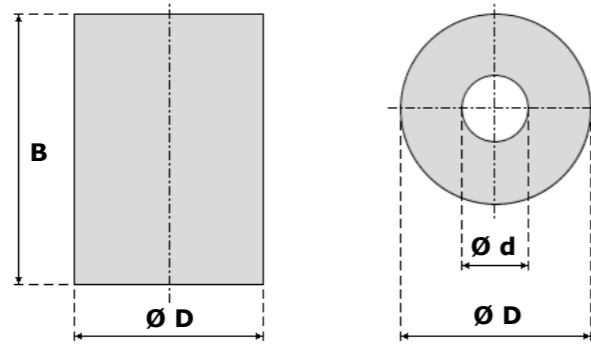

Z=4

Z=6

CODICE	D	B	d	Z
TEPL10012022	100	120	25-40	22
TEPL10013022	100	130	25-40	22
TEPL10014026	100	140	25-40	26
TEPL10015026	100	150	25-40	26
TEPL10016030	100	160	25-40	30
TEPL10018034	100	180	25-40	34

CODICE	D	B	d	Z
TEPL12012033	120	120	25-50	33
TEPL12013033	120	130	25-50	33
TEPL12014039	120	140	25-50	39
TEPL12015039	120	150	25-50	39
TEPL12016045	120	160	25-50	45
TEPL12018051	120	180	25-50	51
TEPL12020057	120	200	25-50	57
TEPL12022063	120	220	25-50	63
TEPL12023063	120	230	25-50	63
TEPL12512033	125	120	25-50	33
TEPL12513033	125	130	25-50	33
TEPL12514039	125	140	25-50	39
TEPL12515039	125	150	25-50	39
TEPL12516045	125	160	25-50	45
TEPL12518051	125	180	25-50	51
TEPL12520057	125	200	25-50	57
TEPL12522063	125	220	25-50	63
TEPL12523063	125	230	25-50	63
TEPL14012033	140	120	25-50	33
TEPL14013033	140	130	25-50	33
TEPL14014039	140	140	25-50	39
TEPL14015039	140	150	25-50	39
TEPL14016045	140	160	25-50	45
TEPL14018051	140	180	25-50	51
TEPL14020057	140	200	25-50	57
TEPL14022063	140	220	25-50	63
TEPL14023063	140	230	25-50	63

### Coltelli reversibili 14x14x2

Reversible knives 14x14x2

HW Messer für hobelsysteme 14x14x2

Cuchillas reversibles HW 14x14x2

Сменные пластины HW 14x14x2

Misure speciali su richiesta - Special sizes on request - Sonderabmessungen auf Anfrage - medidas especiales sobre pedido - Специальные размеры под заказ

## TESTA PORTACOLTELLI ELICOIDALE PER PIALLATURA IN ACCIAIO

Steel spiral planing cutter heads

Stahl spiral Hobelmesserkopf

Cabezales portacuchillas para cepillar en acero

Барабаны с винтовым расположением ножей предварительного строгания из стали

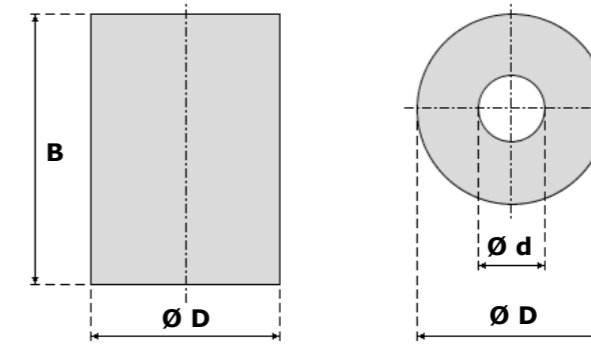

Z=4

Z=6

CODICE	D	B	d	Z
TEPA10012022	100	120	25-40	22
TEPA10013022	100	130	25-40	22
TEPA10014026	100	140	25-40	26
TEPA10015026	100	150	25-40	26
TEPA10016030	100	160	25-40	30
TEPA10018034	100	180	25-40	34

CODICE	D	B	d	Z
TEPA12012033	120	120	25-50	33
TEPA12013033	120	130	25-50	33
TEPA12014039	120	140	25-50	39
TEPA12015039	120	150	25-50	39
TEPA12016045	120	160	25-50	45
TEPA12018051	120	180	25-50	51
TEPA12020057	120	200	25-50	57
TEPA12022063	120	220	25-50	63
TEPA12023063	120	230	25-50	63
TEPA12512033	125	120	25-50	33
TEPA12513033	125	130	25-50	33
TEPA12514039	125	140	25-50	39
TEPA12515039	125	150	25-50	39
TEPA12516045	125	160	25-50	45
TEPA12518051	125	180	25-50	51
TEPA12520057	125	200	25-50	57
TEPA12522063	125	220	25-50	63
TEPA12523063	125	230	25-50	63
TEPA14012033	140	120	25-50	33
TEPA14013033	140	130	25-50	33
TEPA14014039	140	140	25-50	39
TEPA14015039	140	150	25-50	39
TEPA14016045	140	160	25-50	45
TEPA14018051	140	180	25-50	51
TEPA14020057	140	200	25-50	57
TEPA14022063	140	220	25-50	63
TEPA14023063	140	230	25-50	63

### Coltelli reversibili 14x14x2

Reversible knives 14x14x2

HW Messer für hobelsysteme 14x14x2

Cuchillas reversibles HW 14x14x2

Сменные пластины HW 14x14x2

Misure speciali su richiesta - Special sizes on request - Sonderabmessungen auf Anfrage - medidas especiales sobre pedido - Специальные размеры под заказ

## TESTA PORTACOLTELLI ELICOIDALE IN LEGA PER PIALLATURA Z=6

Alluminium spiral planing cutter heads Z=6

Leichtmetal Spiral Hobelmesserkopf Z=6

Cabezales portacuchillas para cepillar en aluminio Z=6

Барабаны с винтовым расположением ножей предварительного строгания из алюминия Z=6

Coltelli reversibili da pag. 38

Reversible knives from page 38

HW Messer für hobelsysteme ab Seite 38

Cuchillas reversibles HW de las páginas 38

Сменные пластины сменные  
твердосплавные ножи

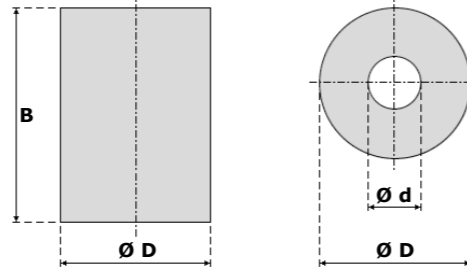

CODICE	D	B	d	Z
TESL10012021	100	120	25-40	21
TESL10013021	100	130	25-40	21
TESL10014024	100	140	25-40	24
TESL10015024	100	150	25-40	24
TESL10016027	100	160	25-40	27
TESL10018030	100	180	25-40	30
TESL12012021	120	120	25-50	21
TESL12013021	120	130	25-50	21
TESL12014024	120	140	25-50	24
TESL12015024	120	150	25-50	24
TESL12016027	120	160	25-50	27
TESL12018030	120	180	25-50	30
TESL12020033	120	200	25-50	33
TESL12022039	120	220	25-50	39
TESL12023039	120	230	25-50	39
TESL12512021	125	120	25-50	21
TESL12513021	125	130	25-50	21
TESL12514024	125	140	25-50	24
TESL12515024	125	150	25-50	24
TESL12516027	125	160	25-50	27
TESL12518030	125	180	25-50	30
TESL12520033	125	200	25-50	33
TESL12522039	125	220	25-50	39
TESL12523039	125	230	25-50	39
TESL14012021	140	120	25-50	21
TESL14013021	140	130	25-50	21
TESL14014024	140	140	25-50	24
TESL14015024	140	150	25-50	24
TESL14016027	140	160	25-50	27
TESL14018030	140	180	25-50	30
TESL14020033	140	200	25-50	33
TESL14022039	140	220	25-50	39
TESL14023039	140	230	25-50	39

Misure speciali su richiesta - Special sizes on request - Sonderabmessungen auf Anfrage - medidas especiales sobre pedido - Специальные размеры под заказ

## TESTA PORTACOLTELLI ELICOIDALE Z=6 IN ACCIAIO PER PIALLATURA

Steel spiral planing cutter heads Z=6

Stahl spiral Hobelmesserkopf Z=6

Cabezales portacuchillas para cepillar en acero Z=6

Барабаны с винтовым расположением ножей предварительного строгания Z=6 из стали

Coltelli reversibili da pag. 38

Reversible knives from page 38

HW Messer für hobelsysteme ab Seite 38

Cuchillas reversibles HW de las páginas 38

Сменные пластины сменные  
твердосплавные ножи

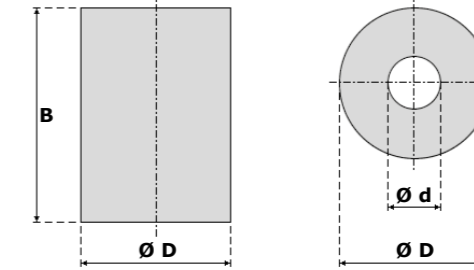

CODICE	D	B	d	Z
TESA10012021	100	120	25-40	21
TESA10013021	100	130	25-40	21
TESA10014024	100	140	25-40	24
TESA10015024	100	150	25-40	24
TESA10016027	100	160	25-40	27
TESA10018030	100	180	25-40	30
TESA12012021	120	120	25-50	21
TESA12013021	120	130	25-50	21
TESA12014024	120	140	25-50	24
TESA12015024	120	150	25-50	24
TESA12016027	120	160	25-50	27
TESA12018030	120	180	25-50	30
TESA12020033	120	200	25-50	33
TESA12022039	120	220	25-50	39
TESA12023039	120	230	25-50	39
TESA12512021	125	120	25-50	21
TESA12513021	125	130	25-50	21
TESA12514024	125	140	25-50	24
TESA12515024	125	150	25-50	24
TESA12516027	125	160	25-50	27
TESA12518030	125	180	25-50	30
TESA12520033	125	200	25-50	33
TESA12522039	125	220	25-50	39
TESA12523039	125	230	25-50	39
TESA14012021	140	120	25-50	21
TESA14013021	140	130	25-50	21
TESA14014024	140	140	25-50	24
TESA14015024	140	150	25-50	24
TESA14016027	140	160	25-50	27
TESA14018030	140	180	25-50	30
TESA14020033	140	200	25-50	33
TESA14022039	140	220	25-50	39
TESA14023039	140	230	25-50	39

Misure speciali su richiesta - Special sizes on request - Sonderabmessungen auf Anfrage - medidas especiales sobre pedido - Специальные размеры под заказ

## FRESA ELICOIDALE MULTITAGLIO Z=12

Multicut Spiral plannig head Z=12

Cabelzal Multidientes Z=12

Mehrschneidiger Hobelkopf Z=12

Фреза спиральная со сменными пластинами z12



CODICE	D	B	d	CODICE	D	d
FEM10012012	100	120	30/50	FEM12526012	260	30/50
FEM10018012	100	180	30/50	FEM1408012	80	30/50
FEM1258012	125	80	30/50	FEM14010012	100	30/50
FEM12510012	125	100	30/50	FEM14012012	120	30/50
FEM12512012	125	120	30/50	FEM14013012	130	30/50
FEM12513012	125	130	30/50	FEM14015012	150	30/50
FEM12513012	125	150	30/50	FEM14016012	160	30/50
FEM12516012	125	160	30/50	FEM14018012	180	30/50
FEM12518012	125	180	30/50	FEM14019012	190	30/50
FEM12519012	125	190	30/50	FEM14020012	200	30/50
FEM12520012	125	200	30/50	FEM14021012	210	30/50
FEM12521012	125	210	30/50	FEM14023012	230	30/50
FEM12523012	125	230	30/50	FEM14024012	240	30/50
FEM12524012	125	240	30/50	FEM14025012	250	30/50
FEM12525012	125	250	30/50	FEM14026012	260	30/50

## FRESA ELICOIDALE MULTITAGLIO PER PIALLARE, SMUSSARE E RAGGIARE Z=14

Multicut spiral cutters for planing and bevelling/radius execution Z=14

Mehrschneidiger Hobelkopf Z=14 für kanten oden abrunden

Cabezal Multidientas Z=14 para redondear o biselar

Фреза со спиральной режущей кромкой для строгания, снятия фаски и радиуса Z=14

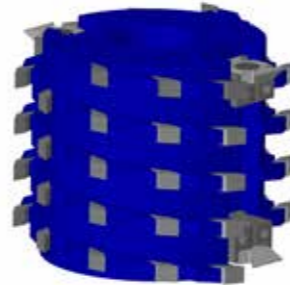

### Z=10

CODICE	D	B	d	S/R
FEMC1008010.4	100	80	30-35	4
FEMC10012010.4	100	120	30-35	4
FEMC10018010.4	100	180	30-35	4

### Z=14

CODICE	B	d	S/R
FEMC1208014.4	80	35-40	4
FEMC12012014.4	120	35-40	4
FEMC12018014.4	180	35-40	4
FEMC1258014.	80	35-40	4
FEMC12512014.	120	35-40	4
FEMC12518014.4	180	35-40	4
FEMC12523014.4	230	35-40	4
FEMC1408014.4	80	35-40	4
FEMC14012014.4	120	35-40	4
FEMC14018014.4	180	35-40	4
FEMC14023014.4	230	35-40	4

## TESTE PORTACOLTELLI PIALLA HYDRO CON INGRASSATORI LATERALI E VERTICALI

Hydro cutter heads for planer knives with lateral grease valve

Hydro Schneidköpfe für die Aufnahme von Hobelmessern mit Seitenseinschmierung

Cabezales portacuchillas de cepillo hydro con engrasadores laterales

Гидрозажимные ножевые барабаны для плоского строгания

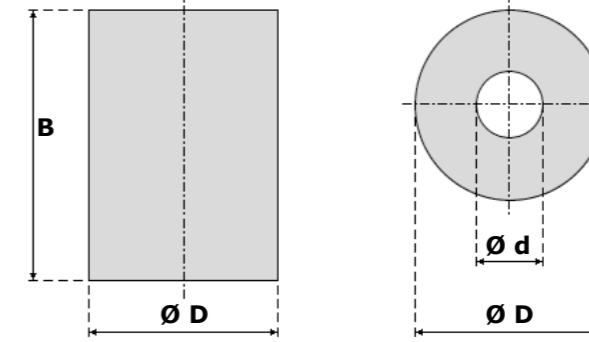

CODICE	Ø D (mm)	B (mm)	Ø d (mm)	Z	CODICE	Ø D (mm)	B (mm)	Ø d (mm)	Z
HPLV163604	163	60	40/45/50	4	HPLV163608	163	60	40/45/50	8
HPLV1631004	163	100	40/45/50	4	HPLV1631008	163	100	40/45/50	8
HPLV1631304	163	130	40/45/50	4	HPLV1631308	163	130	40/45/50	8
HPLV1631504	163	150	40/45/50	4	HPLV1631508	163	150	40/45/50	8
HPLV1631804	163	180	40/45/50	4	HPLV1631808	163	180	40/45/50	8
HPLV1632304	163	230	40/45/50	4	HPLV1632308	163	230	40/45/50	8
HPLV1632604	163	260	40/45/50	4	HPLV1632608	163	260	40/45/50	8
HPLV1633104	163	310	40/45/50	4	HPLV1633108	163	310	40/45/50	8
HPLV163606	163	60	40/45/50	6	HPLV2031008	203	100	40/45/50	8
HPLV1631006	163	100	40/45/50	6	HPLV2031508	203	150	40/45/50	8
HPLV1631306	163	130	40/45/50	6	HPLV2032308	203	230	40/45/50	8
HPLV1631506	163	150	40/45/50	6	HPLV2032608	203	260	40/45/50	8
HPLV1631806	163	180	40/45/50	6	HPLV2033108	203	310	40/45/50	8
HPLV1632306	163	230	40/45/50	6	HPLV2033308	203	330	40/45/50	8
HPLV1632606	163	260	40/45/50	6	HPLV20310010	203	100	40/45/50	10
HPLV1633106	163	310	40/45/50	6	HPLV20315010	203	150	40/45/50	10
HPLV2031006	203	100	40/45/50	6	HPLV20323010	203	230	40/45/50	10
HPLV2031506	203	150	40/45/50	6	HPLV20326010	203	260	40/45/50	10
HPLV2032306	203	230	40/45/50	6	HPLV20331010	203	310	40/45/50	10
HPLV2032606	203	260	40/45/50	6	HPLV20333010	203	330	40/45/50	10
HPLV2033106	203	310	40/45/50	6	HPLV20310012	203	100	40/45/50	12
HPLV2033306	203	330	40/45/50	6	HPLV20315012	203	150	40/45/50	12
					HPLV20323012	203	230	40/45/50	12
					HPLV20326012	203	260	40/45/50	12
					HPLV20331012	203	310	40/45/50	12
					HPLV20333012	203	330	40/45/50	12

## TESTE PORTACOLTELLI RIGATI IN ACCIAIO

Steel cutter heads for corrugated knives

Schneidköpfe für Aufnahme von Blanketts

Cabezales portacuchillas corrugadas en acero

Стальные ножевые барабаны для профильной обработки

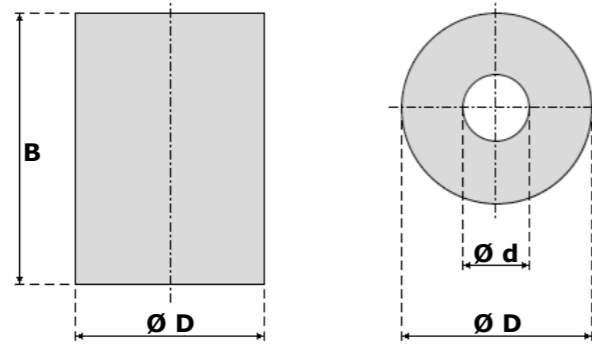

### Z=2

### Z=4

### Z=6

CODICE	D	B	Z	CODICE	D	B	Z	CODICE	D	B	Z
TRA12240 2	122	40	2	TRA122404	122	40	4	TRA122406	122	40	6
TRA122502	122	40	2	TRA122504	122	40	4	TRA122506	122	40	6
TRA122602	122	40	2	TRA122604	122	40	4	TRA122606	122	40	6
TRA122802	122	40	2	TRA122804	122	40	4	TRA122806	122	40	6
TRA1221002	122	40	2	TRA1221004	122	40	4	TRA1221006	122	40	6
TRA1221302	122	40	2	TRA1221304	122	40	4	TRA1221306	122	40	6
TRA1221502	122	40	2	TRA1221504	122	40	4	TRA1221506	122	40	6
TRA1221602	122	40	2	TRA1221604	122	40	4	TRA1221606	122	40	6
TRA1221802	122	40	2	TRA1221804	122	40	4	TRA1221806	122	40	6
TRA1222302	122	40	2	TRA1222304	122	40	4	TRA1222306	122	40	6
TRA1222502	122	40	2	TRA1222504	122	40	4	TRA1222506	122	40	6
TRA137502	137	50	2	TRA137504	137	50	4	TRA137506	137	50	6
TRA137602	137	50	2	TRA137604	137	50	4	TRA137606	137	50	6
TRA137802	137	50	2	TRA137804	137	50	4	TRA137806	137	50	6
TRA1371002	137	50	2	TRA1371004	137	50	4	TRA1371006	137	50	6
TRA1371302	137	50	2	TRA1371304	137	50	4	TRA1371306	137	50	6
TRA1371502	137	50	2	TRA1371504	137	50	4	TRA1371506	137	50	6
TRA1371802	137	50	2	TRA1371804	137	50	4	TRA1371806	137	50	6
TRA1372302	137	50	2	TRA1372304	137	50	4	TRA1372306	137	50	6
TRA1372602	137	50	2	TRA1372604	137	50	4	TRA1372606	137	50	6

Misure speciali su richiesta - Special sizes on request - Sonderabmessungen auf Anfrage - medidas especiales sobre pedido - Специальные размеры под заказ

## TESTE PORTACOLTELLI RIGATI HYDRO CON INGRASSATORI LATERALI E VERTICALI

Hydro cutter heads for corrugated knives with lateral grease valve

Hydro Schneidköpfe für die Aufnahme von Blanketts mit Seitenseinschmierung

Cabezales portacuchillas corrugadas hydro con engrasadores laterales

Гидрозажимные ножевые барабаны для профильной обработки

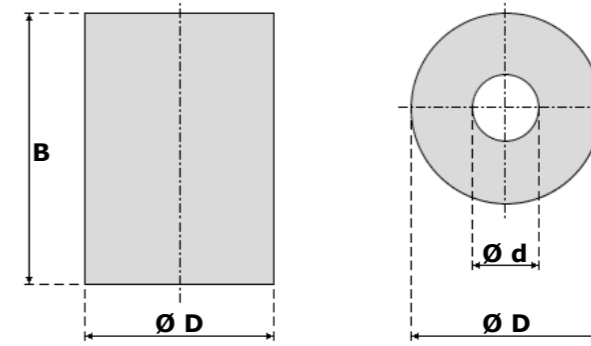

CODICE	Ø D (mm)	B (mm)	Ø d (mm)	Z	CODICE	Ø D (mm)	B (mm)	Ø d (mm)	Z											
HRLV137604	137	60	40/45/50	4	HRLV152606	152	60	40/45/50/60	6											
HRLV137804	137	80	40/45/50	4	HRLV152806	152	80	40/45/50/60	6											
HRLV1371004	137	100	40/45/50	4	HRLV1521006	152	100	40/45/50/60	6											
HRLV1371504	137	150	40/45/50	4	HRLV1521306	152	130	40/45/50/60	6											
					HRLV1521506	152	150	40/45/50/60	6											
					HRLV1521806	152	180	40/45/50/60	6											
					HRLV1522306	152	230	40/45/50/60	6											
					HRLV1522606	152	260	40/45/50/60	6											
					HRLV1523106	152	310	40/45/50/60	6											
					HRLV163606	163	60	40/45/50/60	6	HRLV163608	163	60	40/45/50/60	8						
					HRLV163806	163	80	40/45/50/60	6	HRLV163808	163	80	40/45/50/60	8						
					HRLV1631006	163	100	40/45/50/60	6	HRLV1631008	163	100	40/45/50/60	8						
					HRLV1631306	163	130	40/45/50/60	6	HRLV1631308	163	130	40/45/50/60	8						
					HRLV1631506	163	150	40/45/50/60	6	HRLV1631508	163	150	40/45/50/60	8						
					HRLV1631806	163	180	40/45/50/60	6	HRLV1631808	163	180	40/45/50/60	8						
					HRLV1632306	163	230	40/45/50/60	6	HRLV1632308	163	230	40/45/50/60	8						
					HRLV1632606	163	260	40/45/50/60	6	HRLV1632608	163	260	40/45/50/60	8						
					HRLV1633106	163	310	40/45/50/60	6	HRLV1633108	163	310	40/45/50/60	8						
					HRLV163604	163	60	40/45/50/60	4											
					HRLV163804	163	80	40/45/50/60	4											
					HRLV1631004	163	100	40/45/50/60	4											
					HRLV1631304	163	130	40/45/50/60	4											
					HRLV1631504	163	150	40/45/50/60	4											
					HRLV1631804	163	180	40/45/50/60	4											
					HRLV1632304	163	230	40/45/50/60	4											
					HRLV1632604	163	260	40/45/50/60	4											
					HRLV1633104	163	310	40/45/50/60	4											

Misure speciali su richiesta - Special sizes on request - Sonderabmessungen auf Anfrage - medidas especiales sobre pedido - Специальные размеры под заказ

## FRESE PER GIUNZIONI

Finger Joint Brazed Cutters

Minizinkenfräser

Fresas para empalme

Фрезы для сращивания

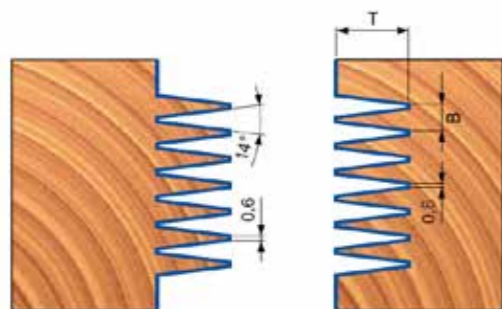

CODICE	∅ D (mm)	B (mm)	∅ d (mm)	Z	T (mm)
FJ160450.2	160	4	50	2	10/11,5
FJ1601050.2	160	10	50	2	10/11,5
FJ160470.2	160	4	70	2	10/11,5
FJ1601070.2	160	10	70	2	10/11,5
FJ160470.4	160	4	50	4	10/11,5
FJ1601050.4	160	10	50	4	10/11,5
FJ160470.4	160	4	70	4	10/11,5
FJ1601070.4	160	10	70	4	10/11,5
FJ250450.6	250	4	50	6	10/11,5
FJ2501050.6	250	10	50	6	10/11,5
FJ250470.6	250	4	70	6	10/11,5
FJ2501070.6	250	10	70	6	10/11,5

**Produzione per lotti minimi da 200 pz., salvo disponibilità in stock**

Minimum quantity 200 pcs, if not available on stock

Mindestmenge von 200 Stück

Mínimo de un lote de producción de 200 piezas

Минимальное количество для производства - 200 штук, за исключением случаев наличия на складе

Misure speciali su richiesta - Special sizes on request - Sonderabmessungen auf Anfrage - medidas especiales sobre pedido - Специальные размеры под заказ

## FRESE ELICOIDALI POSITIVE

HW Solid carbide spiral router bit

VHM Vollhartmetallfräser

HW Fresas helicoidales integral

Фрезы твердосплавные со спиральной режущей кромкой позитивные

# HW SOLID CARBIDE

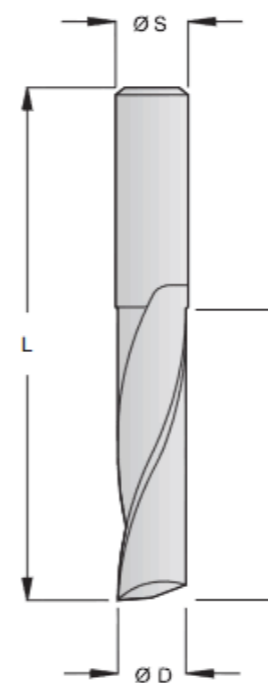

Z=1

∅ D	L	I	POS.
3	50	12	FE1.3-50/12.P
4	50	12	FE1.4-50/12.P
5	50	17	FE1.5-50/17.P
6	60	17	FE1.6-60/17.P
6	60	27	FE1.6-60/27.P
8	80	22	FE1.8-80/22.P
8	80	32	FE1.8/80/32.P
10	80	32	FE110-80/32.P
10	100	42	FE1.10-100/42.P
12	80	32	FE1.12-80/32.P
12	100	42	FE1.12-100/42.P
12	100	52	FE1.12-100/52.P

Z=2

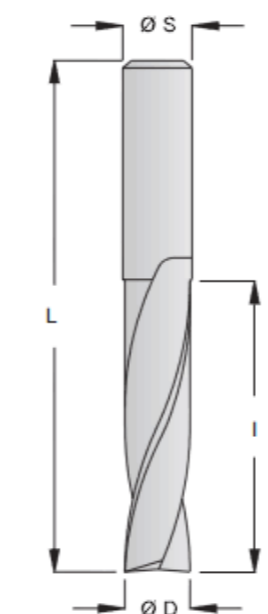

∅ D	L	I	POS.
3	50	12	FE2.3-50/12.P
4	50	12	FE2.4-50/12.P
5	50	17	FE2.5-50/17.P
6	60	17	FE2.6-60/17.P
6	60	27	FE2.6-60/27.P
8	80	22	FE2.8-80/22.P
8	80	32	FE2.8-80/32.P
10	80	32	FE2.10-80/32.P
10	100	42	FE2.10-100/42.P
12	80	32	FE2.12-80/32.P
12	100	42	FE2.12-100/42.P
12	100	52	FE2.12-100/52.P
14	100	42	FE2.14-100/42.P
14	100	52	FE2.14-100/52.P
16	100	42	FE2.16-100/42.P
16	100	52	FE2.16-100/52.P
16	120	72	FE2.16-120/72.P
18	100	52	FE2.18-100/52.P
18	120	72	FE2.18-120/72.P
18	150	102	FE2.18-150/102.P
20	100	52	FE2.20-100/52.P
20	120	72	FE2.20-120/72.P
20	150	102	FE2.20-150/102.P

Misure speciali su richiesta - Special sizes on request - Sonderabmessungen auf Anfrage - medidas especiales sobre pedido - Специальные размеры под заказ

## FRESE ELICOIDALI POSITIVE

HW Solid carbide spiral router bit

VHM Vollhartmetallfräser

HW Fresas helicoidales integral

Фрезы твердосплавные со спиральной режущей кромкой позитивные

**Z=3**

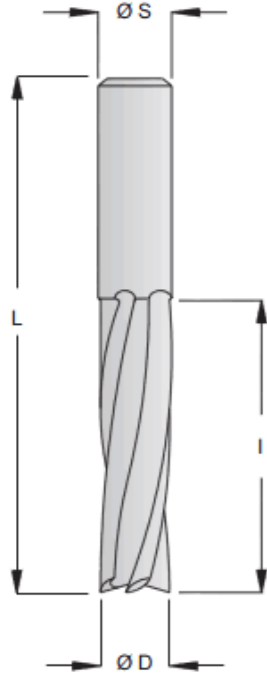

**Z=3**

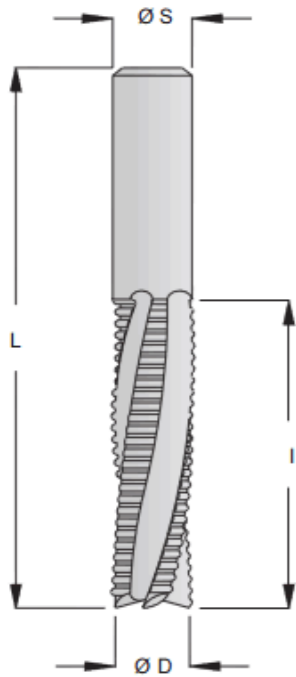

Ø D	L	I	POS.
8	80	22	FE3.8-80/22.P
8	80	32	FE3.8-80/32.P
10	80	32	FE3.10-80/22.P
10	100	42	FE3.10-100/42.P
12	80	32	FE3.12-80/32.P
12	100	42	FE3.12-100/42.P
12	100	52	FE3.12-100/52.P
14	100	42	FE3.14-100/42.P
14	100	52	FE3.14-100/52.P
16	100	42	FE3.16-100/42.P
16	100	52	FE3.16-100/52.P
16	120	72	FE3.16-120/72.P
18	100	52	FE3.18-100/52.P
18	120	72	FE3.18-120/72.P
18	150	102	FE3.18-150/102.P
20	100	52	FE3.20-100/52.P
20	120	72	FE3.20-120/72.P
20	150	102	FE3.20-150/102.P
25	150	102	FE3.25-150/102.P

Ø D	L	I	POS.
8	80	22	FE3R.8-80/22.P
8	80	32	FE3R.8-80/32.P
10	80	32	FE3R.10-80/32.P
10	100	42	FE3R.10-100/42.P
12	80	32	FE3R.12-80/32.P
12	100	42	FE3R.12-100/42.P
12	100	52	FE3R.12-100/52.P
14	100	42	FE3R.14-100/42.P
14	100	52	FE3R.14-100/52.P
16	100	42	FE3R.16-100/42.P
16	100	52	FE3R.16-100/52.P
16	120	72	FE3R.16-120/72.P
18	100	52	FE3R.18-100/52.P
18	120	72	FE3R.18-120/72.P
18	150	102	FE3R.18-150/102.P
20	100	52	FE3R.20-100/52.P
20	120	72	FE3R.20-120/72.P
20	150	102	FE3R.20-150/102.P
25	150	102	FE3R.25-150/102.P

Misure speciali su richiesta - Special sizes on request - Sonderabmessungen auf Anfrage - medidas especiales sobre pedido - Специальные размеры под заказ

## HW

## SOLID CARBIDE

## FRESE ELICOIDALI NEGATIVE

HW Solid carbide spiral router bit

VHM Vollhartmetallfräser

HW Fresas helicoidales integral

Фрезы твердосплавные со спиральной режущей кромкой негативные

**Z=1**



**Z=2**

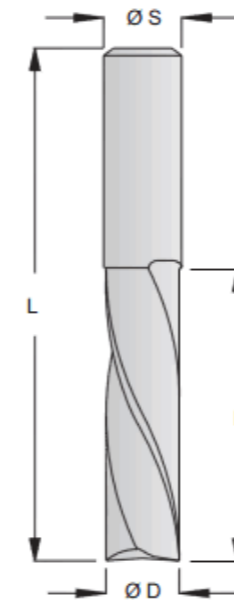

Ø D	L	I	Codice
3	50	12	FE1.3-50/12.N
4	50	12	FE1.4-50/12.N
5	50	17	FE1.5-50/17.N
6	60	17	FE1.6-60/17.N
6	60	27	FE1.6-60/27.N
8	80	22	FE1.8-80/22.N
8	80	32	FE1.8/80/32.N
10	80	32	FE110-80/32.N
10	100	42	FE1.10-100/42.N
12	80	32	FE1.12-80/32.N
12	100	42	FE1.12-100/42.N
12	100	52	FE1.12-100/52.N

Ø D	L	I	Codice
3	50	12	FE2.3-50/12.N
4	50	12	FE2.4-50/12.N
5	50	17	FE2.5-50/17.N
6	60	17	FE2.6-60/17.N
6	60	27	FE2.6-60/27.N
8	80	22	FE2.8-80/22.N
8	80	32	FE2.8-80/32.N
10	80	32	FE2.10-80/32.N
10	100	42	FE2.10-100/42.N
12	80	32	FE2.12-80/32.N
12	100	42	FE2.12-100/42.N
12	100	52	FE2.12-100/52.N
14	100	42	FE2.14-100/42.N
14	100	52	FE2.14-100/52.N
16	100	42	FE2.16-100/42.N
16	100	52	FE2.16-100/52.N
16	120	72	FE2.16-120/72.N
18	100	52	FE2.18-100/52.N
18	120	72	FE2.18-120/72.N
18	150	102	FE2.18-150/102.N
20	100	52	FE2.20-100/52.N
20	120	72	FE2.20-120/72.N
20	150	102	FE2.20-150/102.N

Misure speciali su richiesta - Special sizes on request - Sonderabmessungen auf Anfrage - medidas especiales sobre pedido - Специальные размеры под заказ

## FRESE ELICOIDALI NEGATIVE

HW Solid carbide spiral router bit

VHM Vollhartmetallfräser

HW Fresas helicoidales integral

Фрезы твердосплавные со спиральной режущей кромкой негативные

# HW

## SOLID CARBIDE

Z=3

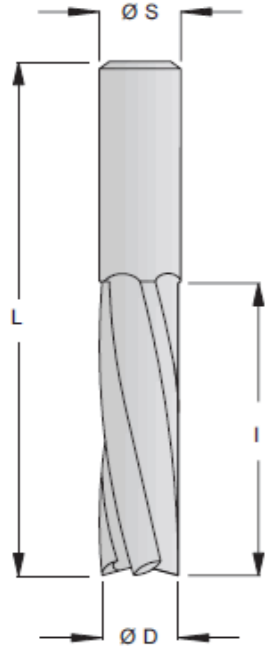

Ø D	L	I	NEG.
8	80	22	FE3.8-80/22.N
8	80	32	FE3.8-80/32.N
10	80	32	FE3.10-80/22.N
10	100	42	FE3.10-100/42.N
12	80	32	FE3.12-80/32.N
12	100	42	FE3.12-100/42.N
12	100	52	FE3.12-100/52.N
14	100	42	FE3.14-100/42.N
14	100	52	FE3.14-100/52.N
16	100	42	FE3.16-100/42.N
16	100	52	FE3.16-100/52.N
16	120	72	FE3.16-120/72.N
18	100	52	FE3.18-100/52.N
18	120	72	FE3.18-120/72.N
18	150	102	FE3.18-150/102.N
20	100	52	FE3.20-100/52.N
20	120	72	FE3.20-120/72.N
20	150	102	FE3.20-150/102.N
25	150	102	FE3.25-150/102.N

Z=3

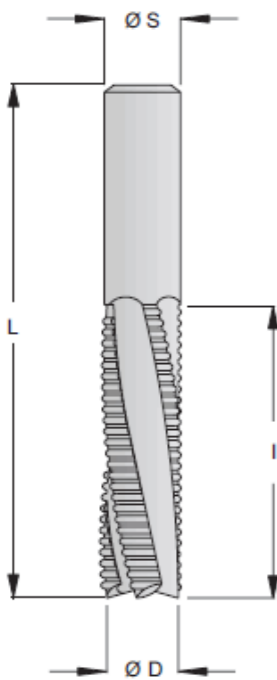

Ø D	L	I	NEG.
8	80	22	FE3R.8-80/22.N
8	80	32	FE3R.8-80/32.N
10	80	32	FE3R.10-80/32.N
10	100	42	FE3R.10-100/42.N
12	80	32	FE3R.12-80/32.N
12	100	42	FE3R.12-100/42.N
12	100	52	FE3R.12-100/52.N
14	100	42	FE3R.14-100/42.N
14	100	52	FE3R.14-100/52.N
16	100	42	FE3R.16-100/42.N
16	100	52	FE3R.16-100/52.N
16	120	72	FE3R.16-120/72.N
18	100	52	FE3R.18-100/52.N
18	120	72	FE3R.18-120/72.N
18	150	102	FE3R.18-150/102.N
20	100	52	FE3R.20-100/52.N
20	120	72	FE3R.20-120/72.N
20	150	102	FE3R.20-150/102.N
25	150	102	FE3R.25-150/102.N

## FRESE ELICOIDALI P/N

HW Solid carbide spiral router bit

VHM Vollhartmetallfräser

HW Fresas helicoidales integral

Фрезы твердосплавные со спиральной режущей кромкой негативные

# HW

## SOLID CARBIDE

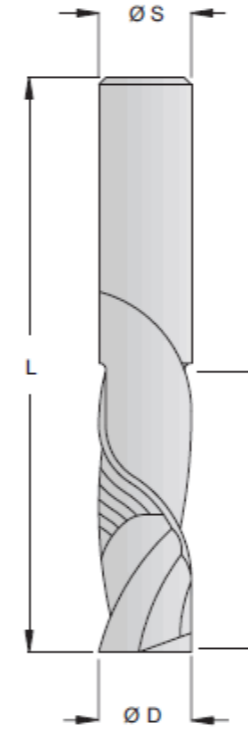

Ø D	L	I	POS/NEG
8	80	22	FE.8-80/22-P/N
8	80	32	FE.8-80/32-P/N
10	80	32	FE.10-80/32-P/N
10	100	42	FE.10-100/42-P/N
12	100	42	FE.12-100/42-P/N
12	100	52	FE.12-100/52-P/N
14	100	42	FE.14-100/42-P/N
14	100	52	FE.14-100/52-P/N
16	100	42	FE.16-100/42-P/N
16	100	52	FE.16-100/52-P/N
18	100	52	FE.18-100/52-P/N
18	120	72	FE.18-120/72-P/N
20	100	52	FE.20-100/52-P/N
20	120	72	FE.20-120/72-P/N

## LAME PER SEGHE A NASTRO

Bandsaw blades

Bandsägeblätter

Cuchillas para sierra de cinta

Ленточные пилы



H (mm)	0.5	0.6	0.7	0.8	0.9	1.00
10		1006				
12		1206				
15	1505	1506	1507			
20	2005	2006	2007			
25	2505	2506	2507	2508		
30		3006	3007	3008		
35			3507	3508	3509	3510
40			4007	4008	4009	4010
45				4508	4509	4510
50				5008	5009	5010

## LAME PER SEGHE A NASTRO STRADATE E AFFILATE

Bandsaw blades setted and sharpened

Bandsägeblätter Standardschränkung

Cuchillas para sierra de cinta

Ленточные пилы

H (mm)	0.5	0.6	0.7	0.8	0.9	1.00
10		1006S				
12		1206S				
15	1505S	1506S	1507S			
20	2005S	2006S	2007S			
25	2505S	2506S	2507S	2508S		
30		3006S	3007S	3008S		
35			3507S	3508S	3509S	3510S
40			4007S	4008S	4009S	4010S
45				4508S	4509S	4510S
50				5008S	5009S	5010S

## LAME CIRCOLARI

Circular saw blades

Kreissägeblatt

Hoja de sierra

Дисковые пилы

Per poter garantire la migliore qualità di taglio, è necessario scegliere la lame più idonea al lavoro da eseguire. Effettuare i dovuti controlli su albero e flange di montaggio e verificare la giusta velocità di rotazione oltre che al perfetto bloccaggio della lama stessa.

Si consiglia che lavorino almeno 2 taglienti contemporaneamente, per poter ottenere una buona qualità di taglio.

*To guarantee the best cutting quality, it's necessary to choose the more suitable saw blade for the job you've do. Carry our any checks in the tree and in the flanges and verify the correct relation speedy. Blade must be perfectly blocked.*

*To obtain a good quality cutting, at least 2 teeth must work at the same time.*

*Um die bestmögliche Schnittgüte zu erreichen ist es notwendig das richtige Messer für die zu verrichtende Arbeit auszusuchen. Die notwendigen Kontrollen an der Welle und dem Flansch vornehmen. Die Drehgeschwindigkeit prüfen und die richtige Fixierung des Messers sicherstellen. Es wird empfohlen dass mindestens 2 Schneiden gleichzeitig arbeiten um eine gute Schnittqualität zu erreichen.*

Para poder garantizar la mejor calidad de corte, es necesario elegir la hoja más idónea al trabajo que ejecutar. Efectuar los debidos controles sobre árbol y arandelas de montaje y averiguar la justa velocidad de rotación más allá de que al perfecto bloqueo de la hoja misma.

Se aconseja que trabajen al mismo tiempo al menos 2 filos en el mismo tiempo, para poder conseguir una buena calidad de corte

*Для гарантии лучшего качества разреза, необходимо выбрать пилу подходящую для конкретного вида работы. Осуществить контроль пилы на валу и фланце, убедится в правильной скорости вращения, а также в том что пила хорошо зафиксирована.*

*Для получения хорошего качества резания, необходимо что бы, как минимум, два зуба пилы работали одновременно.*

## FORI DI TRASCINAMENTO

Pin holes

Nebenlöcher

Agujero

Отверстия под штифт

Cod	Misura	Riferimento macchina
Code	Dimension	Machines
FT 3	2/7/42 + 2/9,5/46,5 + 2/10/60	Universale - Universal
FT 4	2/14/110 + 2/7/110 + 4/9/100 + 4/19/120 + 2/9/130	Gabbiani-SCM-Selco
FT 5	4/15/105 + 3/7/100	Giben - Homag - Macmazza

## LAMA CIRCOLARE UNIVERSALE PER LEGNO

Universal circular saw blade for wood

Universal Kreissägeblatt

Hoja de sierra para empleo universal

Универсальные дисковые пилы для деревообработки

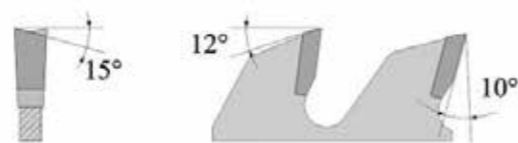

Codice	D	B/b	d	FT	Z
LCU10032/2220.20	100	3,2/2,2	20		20
LCU12032/2220.20	120	3,2/2,2	20		20
LCU12032/2230.30	120	3,2/2,2	30		30
LCU12532/2220.24	125	3,2/2,2	20		24
LCU12532/2230.30	125	3,2/2,2	30		30
LCU14032/2230.24	140	3,2/2,2	30		24
LCU15032/2230.24	150	3,2/2,2	30		24
LCU15032/2230.36	150	3,2/2,2	30		36
LCU16032/2230.24	160	3,2/2,2	30		24
LCU18032/2230.30	180	3,2/2,2	30		30
LCU18032/2230.48	180	3,2/2,2	30		48
LCU20032/2230.34	200	3,2/2,2	30		34
LCU20032/2230.48	200	3,2/2,2	30		48
LCU22032/2230.34	220	3,2/2,2	30		34
LCU22032/2230.48	220	3,2/2,2	30		48
LCU25032/2230.40	250	3,2/2,2	30	FT2	40
LCU25032/2230.60	250	3,2/2,2	30	FT3	60
LCU27532/2230.44	275	3,2/2,2	30	FT3	44
LCU28032/2230.48	280	3,2/2,2	30	FT3	48
LCU30032/2230.48	300	3,2/2,2	30	FT3	48
LCU30032/2230.72	300	3,2/2,2	30	FT3	72
LCU33032/2230.52	330	3,2/2,2	30	FT3	52
LCU33032/2230.72	330	3,2/2,2	30	FT3	72
LCU35035/2530.54	350	3,5/2,5	30	FT3	54
LCU35035/2530.84	350	3,5/2,5	30	FT3	84
LCU40040/2830.60	400	4,0/2,8	30	FT3	60
LCU40040/2830.96	400	4,0/2,8	30	FT3	96
LCU45042/2830.66	450	4,2/2,8	30	2-10-60	66
LCU45042/2835.66	450	4,2/2,8	35		66
LCU45042/2830.72	450	4,2/2,8	30	2-10-60	72
LCU45042/2835.72	450	4,2/2,8	35		72
LCU45042/2830.108	450	4,2/2,8	30	2-10-60	108
LCU45042/2835.108	450	4,2/2,8	35		108
LCU50042/2830.72	500	4,2/2,8	30	2-10-60	72
LCU50042/2835.72	500	4,2/2,8	35		72
LCU50042/3030.120	500	4,2/3,0	30	2-10-60	120
LCU50042/3035.120	500	4,2/2,8	35		120
LCU55052/3630.80	550	5,2/3,6	30	2-10-60	80
LCU55052/3635.80	550	5,2/3,6	35		80
LCU60052/3630.80	600	5,2/3,6	30	2-10-60	80
LCU60052/3635.80	600	5,2/3,6	35		80
LCU70062/4040.84	700	6,2/4,0	40		84

## LAMA CIRCOLARE UNIVERSALE PER TAGLIO LONGITUDINALE

Universal circular saw blade for lengthwise cutting

Universal Kreissägeblatt

Hoja de sierra para empleo cortes longitudinales

Универсальные дисковые пилы для деревообработки для продольной распиловки

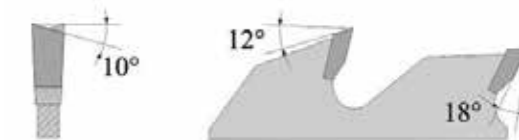

Codice	D	B/b	d	FT	Z	S
LCUTL25032/2230.20	250	3,2/2,2	30	FT3	20	<b>S</b>
LCUTL30032/2230.24	300	3,2/2,2	30	FT3	24	<b>S</b>
LCUTL35035/2530.28	350	3,5/2,5	30	FT3	28	<b>S</b>
LCUTL40040/2830.32	400	4,0/2,8	30	FT3	32	<b>S</b>
LCUTL45042/2830.36	450	4,2/2,8	30	2-10-60	36	
LCUTL45042/2835.36	450	4,2/2,8	35		36	
LCUTL50042/2830.40	500	4,2/2,8	30	2-10-60	40	
LCUTL50042/2835.40	500	4,2/2,8	35		40	
LCUTL55052/3630.44	550	5,2/3,6	30	2-10-60	44	
LCUTL55052/3635.44	550	5,2/3,6	35		44	
LCUTL60052/3630.48	600	5,2/3,6	30	2-10-60	48	
LCUTL60052/3635.48	600	5,2/3,6	35		48	
LCUTL65062/4035.48	650	6,2/4,0	35		48	
LCUTL70062/4030.48	700	6,2/4,0	30	2-10-60	48	

## LAMA CIRCOLARE UNIVERSALE PER TAGLIO TRASVERSALE

Universal circular saw blade for transversal cutting

Universal Kreissägeblatt

Hoja de sierra para cortes transversales

Универсальные дисковые пилы для деревообработки для поперечной распиловки



Codice	D	B/b	d	FT	Z
LCUTT18032/2230.24	180	3,2/2,2	30		24
LCUTT20032/2230.24	200	3,2/2,2	30		24
LCUTT25032/2230.30	250	3,2/2,2	30	FT3	30
LCUTT30032/2230.36	300	3,2/2,2	30	FT3	36
LCUTT35035/2530.42	350	3,5/2,5	30	FT3	42
LCUTT40040/2830.48	400	4,0/2,8	30	FT3	48
LCUTT45042/2830.54	450	4,2/2,8	30	2-10-60	54
LCUTT45042/2835.54	450	4,2/2,8	35		54
LCUTT50042/2830.60	500	4,2/2,8	30	2-10-60	60
LCUTT50042/2835.60	500	4,2/2,8	35		60
LCUTT55052/3630.60	550	5,2/3,6	30	2-10-60	60
LCUTT55052/3635.60	550	5,2/3,6	35		60
LCUTT60052/3630.60	600	5,2/3,6	30	2-10-60	60
LCUTT60052/3635.60	600	5,2/3,6	35		60
LCUTT65062/4035.64	650	6,2/4,0	35		64
LCUTT70062/4030.64	700	6,2/4,0	30	2-10-60	64
LCUTT70062/4040.64	700	6,2/4,0	40		64

## LAMA CIRCOLARE UNIVERSALE HIGH PERFORMANCE

Universal circular saw blade high performance

Universal Kreissägeblatt high performance

Hoja de sierra delgada de alto rendimiento

Универсальные дисковые пилы высокого качества для деревообработки

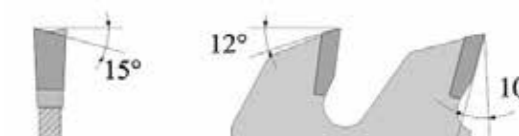

Codice	D	B/b	d	FT	Z
LCUHP10032/2230.30	100	3,2/2,2	30		30
LCUHP12032/2230.36	120	3,2/2,2	30		36
LCUHP15032/2230.48	150	3,2/2,2	30		48
LCUHP16032/2230.48	160	3,2/2,2	30		48
LCUHP18032/2230.56	180	3,2/2,2	30		56
LCUHP20032/2230.64	200	3,2/2,2	30		64
LCUHP22032/2230.64	220	3,2/2,2	30	FT3	64
LCUHP25032/2230.80	250	3,2/2,2	30	FT3	80
LCUHP30032/2230.96	300	3,2/2,2	30	FT3	96
LCUHP32032/2230.96	320	3,2/2,2	30	FT3	96
LCUHP33032/2230.96	330	3,2/2,2	30	FT3	96
LCUHP35035/2530.108	350	3,5/2,5	30	FT3	108
LCUHP40040/2830.120	400	4,0/2,8	30	FT3	120
LCUHP45042/3030.132	450	4,2/3,0	30	2-10-60	132
LCUHP45042/3035.132	450	3,2/2,2	35		132
LCUHP50042/3030.144	500	4,2/3,0	30	2-10-60	144
LCUHP50042/3035.144	500	4,2/3,0	35		144

## LAMA CIRCOLARE CON LIMITATORE DI TRUCIOLO

Circular saw blade with chip-limiter

Sägeblätter Wechselzahn

Hoja de sierra para cortes longitudinales con limitador de espesor de viruta

Дисковые пилы с ограничением подачи

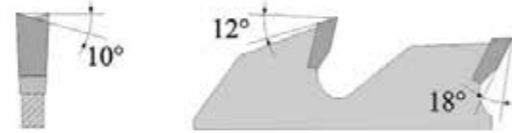

Codice	D	B/b	d	FT	Z	S
LCULT25032/2230.24	250	3,2/2,2	30	FT3	24	S
LCULT30032/2230.28	300	3,2/2,2	30	FT3	28	S
LCULT35035/2530.32	350	3,5/2,5	30	FT3	32	S
LCULT40040/2830.36	400	4,0/2,8	30	FT3	36	S
LCULT45042/2830.40	450	4,2/2,8	30	2-10-60	40	
LCULT45042/2835.40	450	4,2/2,8	35		40	
LCULT50042/2830.44	500	4,2/2,8	30	2-10-60	44	
LCULT50042/2835.44	500	4,2/2,8	35		44	
LCULT55052/3630.48	550	5,2/3,6	30	2-10-60	48	
LCULT55052/3635.48	550	5,2/3,6	35		48	
LCULT60052/3630.48	600	5,2/3,6	30	2-10-60	48	
LCULT60052/3635.48	600	5,2/3,6	35		48	
LCULT65062/4035.48	650	6,2/4,0	35		48	
LCULT70062/4030.48	700	6,2/4,0	30		48	

## LAMA CIRCOLARE UNIVERSALE SPESSORE SOTTILE

Universal thin circular saw blade

Universal kreissägeblatt mit dünne schnittbreite

Hoja de sierra delgada para empleo universal

Универсальные дисковые пилы с тонким пропилом



Codice	D	B/b	d	FT	Z
LCUS15025/1830.24	150	2,5/1,8	30		24
LCUS18025/1830.30	180	2,5/1,8	30		30
LCUS20025/1830.34	200	2,5/1,8	30		34
LCUS20025/1830.48	200	2,5/1,8	30		48
LCUS25025/1830.40	250	2,5/1,8	30	FT3	40
LCUS25025/1830.60	250	2,5/1,8	30	FT3	60
LCUS30025/1830.48	300	2,5/1,8	30	FT3	48
LCUS30025/1830.72	300	2,5/1,8	30	FT3	72
LCUS35028/2030.54	350	2,8/2,0	30	FT3	54
LCUS35028/2030.84	350	2,8/2,0	30	FT3	84
LCUS40036/2530.60	400	3,6/2,5	30	FT3	60
LCUS40036/2530.96	400	3,6/2,5	30	FT3	96

## LAMA CIRCOLARE UNIVERSALE SPESSORE SOTTILE HIGH PERFORMANCE

Universal thin circular saw blade high performance

Universal kreissägeblatt mit dünne schnittbreite high performance

Hoja de sierra delgada de alto rendimiento

Универсальные дисковые пилы высокого качества с тонким пропилом



Codice	D	B/b	d	FT	Z
LCUSHP15025/1830.48	150	2,5/1,8	30		48
LCUSHP20025/1830.64	200	2,5/1,8	30		64
LCUSHP25025/1830.80	250	2,5/1,8	30		80
LCUSHP30025/1830.96	300	2,5/1,8	30		96

## LAMA CIRCOLARE UNIVERSALE HIGH PERFORMANCE ULTRA SILENZIATA

Universal circular saw blade extra noisless

Universal gerauscharm kreissägeblatt

Hoja de sierra para empleo universal

Универсальные дисковые пилы с низким уровнем шума



Codice	D	B/b	d	FT	Z
LCUHPUS25032/2230.40	250	3,2/2,2	30	FT3	40
LCUHPUS25032/2230.60	250	3,2/2,2	30	FT3	60
LCUHPUS25032/2230.80	250	3,2/2,2	30	FT3	80
LCUHPUS30032/2230.48	300	3,2/2,2	30	FT3	48
LCUHPUS30032/2230.60	300	3,2/2,2	30	FT3	60
LCUHPUS30032/2230.72	300	3,2/2,2	30	FT3	72
LCUHPUS30032/2230.96	300	3,2/2,2	30	FT3	96
LCUHPUS35035/2530.54	350	3,5/2,5	30	FT3	54
LCUHPUS35035/2530.72	350	3,5/2,5	30	FT3	72
LCUHPUS35035/2530.84	350	3,5/2,5	30	FT3	84
LCUHPUS35035/2530.108	350	3,5/2,5	30	FT3	108
LCUHPUS40040/2830.60	400	4,0/2,8	30	FT3	60
LCUHPUS40040/2830.80	400	4,0/2,8	30	FT3	80
LCUHPUS40040/2830.96	400	4,0/2,8	30	FT3	96
LCUHPUS40040/2830.120	400	4,0/2,8	30	FT3	120

## LAMA CIRCOLARE MULTILAMA CON RASANTE

Circular saw blade for multirip machines with shavings

Kreissägeblatt für mehrblattmaschinen mit hm-reumern

Hoja de sierra con rasantes para sierra multiple

Дисковые пилы с подрезными ножами для многопильного станка

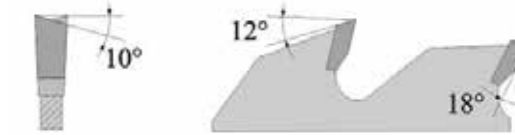

Codice	D	B/b	d	FT	Z	R	HT
LCMR25032/2230.20-2+2	250	3,2/2,2	30	FT3	20	2+2	65
LCMR25032/2260.20-2+2	250	3,2/2,2	60	21x74	20	2+2	65
LCMR25032/2270.20-2+2	250	3,2/2,2	70	21x84	20	2+2	65
LCMR25032/2280.20-2+2	250	3,2/2,2	80	13x90	20	2+2	65
LCMR30032/2230.24 2+2	300	3,2/2,2	30	FT3	24	2+2	80
LCMR30032/2260.24 2+2	300	3,2/2,2	60	21x74	24	2+2	80
LCMR30032/2270.24 2+2	300	3,2/2,2	70	21x84	24	2+2	80
LCMR30032/2275.24 2+2	300	3,2/2,2	75	21x91	24	2+2	80
LCMR30032/2280.24 2+2	300	3,2/2,2	80	13x90	24	2+2	80
LCMR30032/2280.24 2+2R	300	3,2/2,2	80	RAIMANN	24	2+2	80
LCMR32032/2270.24 2+2	320	3,2/2,2	70	21x84	24	2+2	90
LCMR32032/2280.24 2+2	320	3,2/2,2	80	13x90	24	2+2	90
LCMR35035/2530.24 2+4	350	3,5/2,5	30	FT3	24	2+4	105
LCMR35035/2560.24 2+4	350	3,5/2,5	60	21x74	24	2+4	105
LCMR35035/2570.24 2+4	350	3,5/2,5	70	21x84	24	2+4	105
LCMR35035/2575.24 2+4	350	3,5/2,5	75	21x91	24	2+4	105
LCMR35035/2580.24 2+4	350	3,5/2,5	80	14x92	24	2+4	105
LCMR35035/2580.24 2+4R	350	3,5/2,5	80	RAIMANN	24	2+4	105
LCMR35035/2590.24 2+4	350	3,5/2,5	90	21x110	24	2+4	95

## LAMA CIRCOLARE MULTILAMA CON RASANTE

Circular saw blade for multirip machines with shavings

Kreissägeblatt für mehrblattmaschinen mit hm-reumern

Hoja de sierra con rasantes para sierra multiple

Дисковые пилы с подрезными ножами для многопильного станка

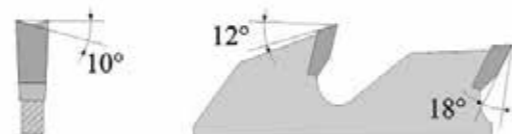

Codice	D	B/b	d	FT	Z	R	HT
LCMR40040/2830.28 2+4	400	4,0/2,8	30	FT3	28	2+4	120
LCMR40040/2870.28 2+4	400	4,0/2,8	70	21X84	28	2+4	120
LCMR40040/2874.28 2+4	400	4,0/2,8	75	21X91	28	2+4	120
LCMR40040/2880.28 2+4	400	4,0/2,8	80	14X92	28	2+4	120
LCMR40040/2890.28 2+4	400	4,0/2,8	90	21X110	28	2+4	120
LCMR45046/3230.24 2+4	450	4,6/3,2	30		24	2+4	135
LCMR45046/3270.24 2+4	450	4,6/3,2	70	21X84	24	2+4	135
LCMR45046/3275.24 2+4	450	4,6/3,2	75	21X91	24	2+4	135
LCMR45046/3280.24 2+4	450	4,6/3,2	80	13X92	24	2+4	135
LCMR45046/3290.24 2+4	450	4,6/3,2	90	21X110	24	2+4	135
LCMR50046/3230.26 2+6	500	4,6/3,2	30		26	2+6	175
LCMR50046/3270.26 2+6	500	4,6/3,2	70	21X84	26	2+6	175
LCMR50046/3280.26 2+6	500	4,6/3,2	80	13X92	26	2+6	175
LCMR55048/3630.28 2+6	550	4,8/3,6	30		28	2+6	175

## LAMA CIRCOLARE MULTILAMA SPESSORE GROSSO CON RASANTE

Thick circular saw blade for multirip saw machine with shavings

Kreissägeblatt grosse dicke für mehrblattmaschinen mit hm-reumern

Hoja de sierra espesa con rasadores para multihojas

Дисковые пилы для многопильного станка с утолщенным корпусом и с подрезными ножами

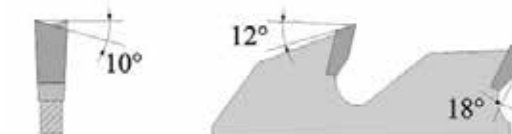

Codice	D	B/b	d	FT	Z	R	HT
LCMRSP250402870.20-2/2	250	4,0/2,8	70	21X84	20	2+2	65
LCMRSP25040/2880.20 2+2	250	4,0/2,8	80	13X90	20	2+2	65
LCMRSP30040/2870.24 2+2	300	4,0/2,8	70	21X84	24	2+2	80
LCMRSP30040/2880.24 2+2	300	4,0/2,8	80	13X90	24	2+2	80
LCMRSP30052/3670.24 2+2	300	5,2/3,6	70	21X84	24	2+2	80
LCMRSP30052/3675.24 2+2	300	5,2/3,6	75	21X91	24	2+2	80
LCMRSP30052/3680.24 2+2	300	5,2/3,6	80	13X90	24	2+2	80
LCMRSP30052/3680.24 2+2	300	5,2/3,6	80	13X90	24	2+2	90
LCMRSP35042/2870.24 2+4	350	4,2/2,8	70	21X84	24	2+4	105
LCMRSP35042/2875.24 2+4	350	4,2/2,8	75	21X91	24	2+4	105
LCMRSP35042/2880.24 2+4	350	4,2/2,8	80	14X92	24	2+4	105
LCMRSP35052/3670.24 2+4	350	5,2/3,6	70	21X84	24	2+4	105
LCMRSP35052/3675.24 2+4	350	5,2/3,6	75	21X91	24	2+4	105

### LAMA CIRCOLARE MULTILAMA SOTTILE CON RASANTE

Circular saw blade for multirip saw machine thin thickness with shavings

Kreissägeblatt für mehrblattmaschinen mit hm-reumern mit dünne schnittbreite

Hoja de sierra delgada con rasadores

Дисковые пилы с тонким пропилом с подрезными ножами для многопильного станка



Codice	D	B/b	d	FT	Z	R	HT
LCMRS18025/1840.21 3	180	2,5/1,8	40		21	3	30
LCMRS20025/1840.21 3	200	2,5/1,8	40		21	3	35
LCMRS25027/1870.20 2+2	250	2,7/1,8	70	21x84	20	2+2	50
LCMRS25027/1880.20 2+2	250	2,7/1,8	80	13x90	20	2+2	50
LCMRS30027/1870.24 2+2	300	2,7/1,8	70	21x84	24	2+2	60
LCMRS30027/1880.24 2+2	300	2,7/1,8	80	13x90	24	2+2	60

### LAMA CIRCOLARE PER LAMINATI

Circular saw blade for plastic laminated panels

Kreissägeblatt für schichtstoffplatten

Hoja de sierra para tableros estratificados

Дисковые пилы для форматно-раскроечных станков

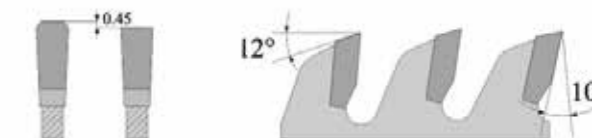

Codice	D	B/b	d	FT	Z	R	HT
LCL20032/2230.64	200	3,2/2,2	30	FT3	64		
LCL22032/2230.64	220	3,2/2,2	30	FT3	64		
LCL25032/2230.60	250	3,2/2,2	30	FT3	60		
LCL25032/2230.80	250	3,2/2,2	30	FT3	80		
LCL30032/2230.72	300	3,2/2,2	30	FT3	72		
LCL30032/2230.96	300	3,2/2,2	30	FT3	96		
LCL35035/2530.84	350	3,5/2,5	30	FT3	84		
LCL35035/2530108	350	3,5/2,5	30	FT3	108		

### LAMA CIRCOLARE PER LAMINATI DENTE CONCAVO

Circular saw blade for plastic laminated panels with hollow tooth

Kreissägeblatt holzspanplatten

Hoja de sierra para tableros estratificados con dientes concave

Дисковые пилы для раскроя ламинированного ДСП и пластика с вогнутым зубом

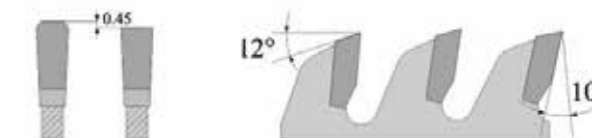

Codice	D	B/b	d	FT	Z
LCLTC22032/2230.42	220	3,2/2,2	30	FT3	42
LCLTC25032/2230.48	250	3,2/2,2	30	FT3	48
LCLTC30032/2230.60	300	3,2/2,2	30	FT3	60
LCLTC30332/2230.60	303	3,2/2,2	30	FT3	60
LCLTC35035/2530.72	350	3,5/2,5	30	FT3	72

## LAMA CIRCOLARE SEZIONATRICE DENTE ALTERNO CON SILENZIATURA PIENA

Circular panel sizing saw blade alternate bevel tooth full noiseless

Gerauscharm kreissägeblatt für plattenaufteil maschinen  
hartmetall bestückt wechsell Zahn – korper mit mikroschlitz  
Hoja de sierra para despiedadora con diente alterno

Дисковая пила для форматно-раскроечных станков и центров с низким уровнем шума



Codice	D	B/b	d	FT	Z
30044/3230.48	300	4,4/3,2	30	FT3	48
30044/3230.60	300	4,4/3,2	30	FT3	60
35044/3230.54	350	4,4/3,2	30	FT3	54
35044/3275.53	350	4,4/3,2	75	FT5	54
35044/3280.54	350	4,4/3,2	80	FT4	54
35044/3275.72	350	4,4/3,2	75	FT5	72
35044/3280.72	350	4,4/3,2	80	FT4	72
40044/3230.60	400	4,4/3,2	30	2-10-60	60
40044/3275.60	400	4,4/3,2	75	GIBEN-HOMAG	60
40044/3280.60	400	4,4/3,2	80	FT4	60
40044/3230.72	400	4,4/3,2	30	2-10-60	72
40044/3275.72	400	4,4/3,2	75	GIBEN-HOMAG	72
40044/3280.72	400	4,4/3,2	80	FT4	72
45044/3230.54	450	4,4/3,2	30	2- 10- 60 Shelling	54
45044/3230.72	450	4,4/3,2	30	2- 10- 60 Shelling	72
50046/3230.72	500	4,6/3,2	30	2- 10- 60 Shelling	72

## LAMA CIRCOLARE SEZIONATRICE DENTE TRAPEZIO-PIANO CON SILENZIATURA PIENA

Circular panel sizing saw blade trapezoidal-flat tooth full noiseless

Gerauscharm kreissägeblatt für plattenaufteil maschinen mit hartmetall bestückt trapez und flachzahn  
Hoja de sierra para despiedadora con diente trapezoidal - recto

Дисковая пила для форматно-раскроечных станков и центров с трапецивидным зубом и с низким уровнем шума

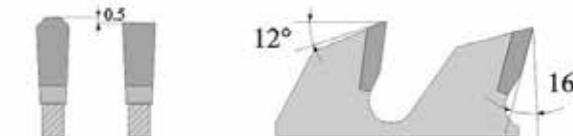

Codice	D	B/b	d	FT	Z
LCSTP30044/3230.60	300	4,4/3,2	30		60
LCSTP30044/3265.60	300	4,4/32	65	Selco	60
LCSTP30044/3275.60	300	4,4/32	75	Homag	60
LCSTP30044/3280.60	300	4,4/32	80	Gabbiani	60
LCSTP30044/3230.72	300	4,4/32	30	FT3	72
LCSTP30044/3280.72	300	4,4/32	80	Gabbiani	72
LCSTP32044/3250.60	320	4,4/3,2	50	Giben	60
LCSTP32044/3265.60	320	4,4/3,2	65	Selco	60
LCSTP32044/3250.72	320	4,4/3,2	50	Giben	72
LCSTP32044/3275.72	320	4,4/3,2	75	Giben	72
LCSTP33044/3250.60	330	4,4/3,2	50	Giben	60
LCSTP350425/3230.72	350	42,5/3,2	30	FT3	72
LCSTP35044/3230.54	350	4,4/3,2	30	FT3	54
LCSTP35044/3275.54	350	4,4/3,2	75	FT5	54
LCSTP35044/3280.54	350	4,4/3,2	80	FT4	54
LCSTP35044/3230.72	350	4,4/3,2	30	FT3	72
LCSTP35044/3250.72	350	4,4/3,2	50	Giben	72
LCSTP35044/3260.72	350	4,4/3,2	60	Holzma	72
LCSTP35044/3265.72	350	4,4/3,2	65	Selco	72
LCSTP35044/3275.72	350	4,4/3,2	75	FT5	72
LCSTP35044/3280.72	350	4,4/3,2	80	FT4	72
LCSTP35544/3230.72	355	4,4/3,2	30	FT3	72
LCSTP35544/3275.72	355	4,4/3,2	75	FT5	72
LCSTP35544/3280.72	355	4,4/3,2	80	FT4	72
LCSTP36044/3250.72	360	4,4/3,2	50	Giben	72
LCSTP36044/3265.72	360	4,4/3,2	65	Selco	72
LCSTP37044/3230.72	370	4,4/3,2	30	Schelling	72
LCSTP38044/3250.72	380	4,4/3,2	50	Giben	72
LCSTP38044/3260.72	380	4,4/3,2	60	Holzma	72
LCSTP38044/3280.72	380	4,4/3,2	80	FT4	72
LCSTP38048/3560.72	380	4,8/3,5	60	Holzma	72

## LAMA CIRCOLARE SEZIONATRICE DENTE TRAPEZIO-PIANO CON SILENZIATURA PIENA

Circular panel sizing saw blade trapezoidal-flat tooth full noiseless

Gerauscharm kreissägeblatt für plattenaufteilmaschinen mit hartmetall bestückt trapez und flachzahn

Hoja de sierra para despiezadora con diente trapezoidal - recto

Дисковая пила для форматно-раскroечных станков и центров с трапецивидным зубом и с низким уровнем шума

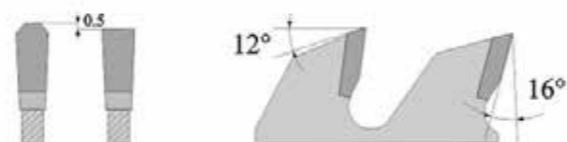

Codice	D	B/b	d	FT	Z
LCSTP400425/3230.72	400	4,25/3,2	30	2-10-60	72
LCSTP40044/3230.60	400	4,4/3,2	30	2-10-60	60
LCSTP40044/3275.60	400	4,4/3,2	75	Giben Homag	60
LCSTP40044/3280.60	400	4,4/3,2	80	FT4	60
LCSTP40044/3230.72	400	4,4/3,2	30	2-10-60	72
LCSTP40044/3260.72	400	4,4/3,2	60	Anthon	72
LCSTP40044/3275.72	400	4,4/3,2	75	Giben Homag	72
LCSTP40044/3280.72	400	4,4/3,2	80	FT4	72
LCSTP40046/3280.72	400	4,6/3,2	80	FT4	72
LCSTP42044/3280.72	420	4,4/3,2	80	FT4	72
LCSTP42048/3560.72	420	4,8/3,5	60	Holzma	72
LCSTP43044/3275.72	430	4,4/3,2	75	Giben	72
LCSTP43044/3280.72	430	4,4/3,2	80	FT4	72
LCSTP45044/3230.72	450	4,4/3,2	30	Schelling	72
LCSTP45044/3275.72	450	4,4/3,2	75	Macmazza	72
LCSTP45044/3280.72	450	4,4/3,2	80	FT4	72
LCSTP45048/3560.72	450	4,8/3,5	60	Holzma	72
LCSTP45048/3580.72	450	4,8/3,5	80	FT4	72
LCSTP46044/3230.72	460	4,4/3,2	30	Schelling	72
LCSTP47044/3275.72	470	4,4/3,2	75	Giben	72
LCSTP47044/3275.96	470	4,4/3,2	75	Giben	96
LCSTP48044/3230.72	480	4,4/3,2	30	Schelling	72
LCSTP50048/3560.60	500	4,8/3,5	60	Holzma	60
LCSTP50048/3560.72	500	4,8/3,5	60	Holzma	72
LCSTP52048/3560.60	520	4,8/3,5	60	Holzma	60
LCSTP52048/3530.72	520	4,8/3,5	70	Selco	72
LCSTP55052/3540.60	550	5,2/3,5	40	Schelling	60
LCSTP57048/3560.60	570	4,8/3,5	60	Holzma	60

## LAMA AD INCISORE CONICO PER SEZIONATRICE

Dividing scoring saw blade

Konische ritz-kreissägeblatt

Incisor para el despiezado de tableros

Подрезная пила коническая

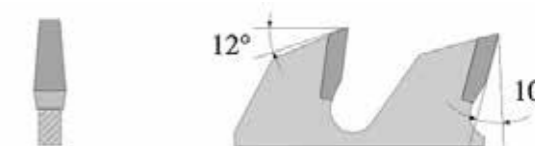

Codice	D	B	b	d	FT	Z
LCI8031-40/2220.12	80	3,1/4,0	2,2	20		12
LCI9030-41/2230.12	90	3,0/4,1	2,2	30		12
LCI10031-43/2220.20	100	3,1/4,3	2,2	20		20
LCI11031-43/2220.20	110	3,1/4,3	2,2	20		20
LCI12031-43/2220.20	120	3,1/4,3	2,2	20		20
LCI12031-43/2222.20	120	3,1/4,3	2,2	22		20
LCI12531-43/2220.24	125	3,1/4,3	2,2	20		24
LCI12531-43/2222.24	125	3,1/4,3	2,2	22		24
LCI12534-45/2220.24	125	3,4/4,5	2,2	20		24
LCI12543-55/3220.24	125	4,3/5,5	3,2	20		24
LCI12543-55/3245.24	125	4,3/5,5	3,2	45		24
LCI15043-55/3230.24	150	4,3/5,5	3,2	30		24
LCI15043-55/3245.24	150	4,3/5,5	3,2	45		24
LCI15031-43/2230.36	150	3,1/4,3	2,2	30		36
LCI15034-45/2230.36	150	3,4/4,5	2,2	30		36
LCI15043-55/3230.36	150	4,3/5,5	3,2	30		36
LCI15043-55/3245.36	150	4,3/5,5	3,2	45	GIBEN	36
LCI16043-55/3220.36	160	4,3/5,5	3,2	20		36
LCI16043-55/3230.36	160	4,3/5,5	3,2	30	GIBEN	36
LCI16043-55/3245.36	160	4,3/5,5	3,2	45	GABBIANI	36
LCI16043-55/3255.36	160	4,3/5,5	3,2	55	MACMAZZA	36
LCI16045-57/3255.36	160	4,5/5,7	3,2	55	GABBIANI	36

## LAMA AD INCISORE CONICO PER SEZIONATRICE

Dividing scoring saw blade

Konische ritz-kreissägeblatt

Incisor para el despiezado de tableros

Подрезная пила коническая

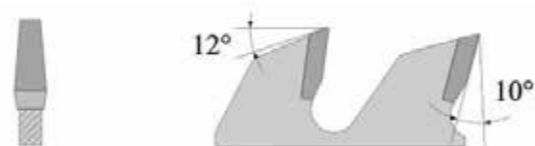

Codice	D	B	b	d	FT	Z
LCI18043-55/3220.36	180	4,3/5,5	3,2	20		36
LCI18043-55/3230.36	180	4,3/5,5	3,2	30		36
LCI18043-55/3245.36	180	4,3/5,5	3,2	45	HOLZMA	36
LCI18047-60/3545.36	180	4,7/6,0	3,5	45	HOLZMA	36
LCI18043-55/3250.44	180	4,3/5,5	3,2	50	GIBEN	44
LCI20043-55/3220.36	200	4,3/5,5	3,2	20		36
LCI20043-55/3230.36	200	4,3/5,5	3,2	30		36
LCI20043-55/3245.36	200	4,3/5,5	3,2	45	HOLZMA	36
LCI20043-55/3265.36	200	4,3/5,5	3,2	65	SELCO	36
LCI20043-55/3280.36	200	4,3/5,5	3,2	80	GABBIANI	36
LCI20045-57/3265.36	200	4,5/5,7	3,2	65	SELCO	36
LCI20047-60/3545.36	200	4,7/6,0	3,5	45	HOLZMA	36
LCI20047-60/3565.36	200	4,7/6,0	3,5	65	SELCO	36
LCI20050-62/3520.36	200	5,0/6,2	3,5	20	SHELLING	36
LCI20058-70/4045.36	200	5,8/7,0	4,0	45	HOLZMA	36
LCI21543-55/3250.42	215	4,3/5,5	3,2	50	GIBEN	42
LCI30043-55/3250.48	300	4,3/5,5	3,2	50	GIBEN	48
LCI30043-55/3265.72	300	4,3/5,5	3,2	65	SELCO	72
LCI30045-57/3265.72	300	4,5/5,7	3,2	65	SELCO	72

## LAMA INCISORE REGOLABILE

Adjustable dividing scoring saw blade

Verstellbarritz kreissägeblatt

Incisor para el despiezado de tableros

Подрезная пила регулируемая



Codice	D	B	b	d	Z
LCIR7028-36/2220.8	70	2,8/3,6	2,2	20	8+8
LCIR8028-36/2220.10	80	2,8/3,6	2,2	20	10+10
LCIR10028-36/2220.10	100	2,8/3,6	2,2	20	10+10
LCIR10028-36/2222.10	100	2,8/3,6	2,2	22	10+10
LCIR12028-36/2220.12	120	2,8/3,6	2,2	20	12+12
LCIR12028-36/2222.12	120	2,8/3,6	2,2	22	12+12
LCIR12528-36/2220.12	125	2,8/3,6	2,2	20	12+12
LCIR12528-36/2222.12	125	2,8/3,6	2,2	22	12+12

## LAMA CIRCOLARE PER SCANALATURE

Grooving circular saw blade

Nut kreissägeblatt

Hoja de sierra para ranurar

Дисковая пила для пазов

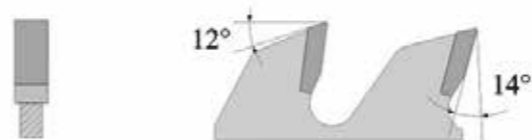

Codice	D	B/b	d	FT	Z
LCS12515/1130.12	125	1,5/1,2	30		12
LCS12518/1330.12	125	1,8/1,2	30		12
LCS12520/1430.12	125	2,0/1,4	30		12
LCS12525/1630.12	125	2,5/1,6	30		12
LCS12530/2030.12	125	3,0/2,0	30		12
LCS12535/2530.12	125	3,5/2,5	30		12
LCS12540/2830.12	125	4,0/2,8	30		12
LCS12545/3230.12	125	4,5/3,2	30		12
LCS12550/4030.12	125	5,0/4,0	30		12
LCS12560/4030.12	125	6,0/4,0	30		12
LCS12570/6030.12	125	7,0/6,0	30		12
LCS12580/6030.12	125	8,0/6,0	30		12
LCS12590/6030.12	125	9,0/6,0	30		12
LCS125100/6030.12	125	10,0/6,0	30		12
LCS15015/1130.18	150	1,5/1,2	30		18
LCS15018/1330.18	150	1,8/1,2	30		18
LCS15020/1430.18	150	2,0/1,4	30		18
LCS15025/1630.18	150	2,5/1,6	30		18
LCS15030/2030.18	150	3,0/2,0	30		18
LCS15035/2530.18	150	3,5/2,5	30		18
LCS15040/2830.18	150	4,0/2,8	30		18
LCS15050/4030.18	150	5,0/4,0	30		18
LCS15060/4030.18	150	6,0/4,0	30		18
LCS15070/6030.18	150	7,0/6,0	30		18
LCS15080/6030.18	150	8,0/6,0	30		18
LCS15090/6030.18	150	9,0/6,0	30		18
LCS150100/6030.18	150	10,0/6,0	30		18
LCS18020/1430.24	180	2,0/1,4	30		24
LCS18025/1630.24	180	2,5/1,6	30		24
LCS18030/2030.24	180	3,0/2,0	30		24
LCS18035/2530.24	180	3,5/2,5	30		24
LCS18040/2830.24	180	4,0/2,8	30		24
LCS18050/4030.24	180	5,0/4,0	30		24

## LAMA CIRCOLARE PER SCANALATURE

Grooving circular saw blade

Nut kreissägeblatt

Hoja de sierra para ranurar

Дисковая пила для пазов

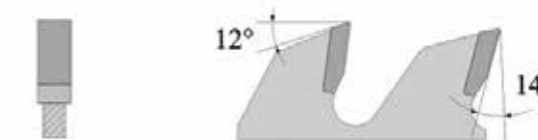

Codice	D	B/b	d	FT	Z
LCS18060/4030.24	180	6,0/4,0	30		24
LCS18070/6030.24	180	7,0/6,0	30		24
LCS18080/6030.24	180	8,0/6,0	30		24
LCS18090/6030.24	180	9,0/6,0	30		24
LCS180100/6030.24	180	10,0/6,0	30		24
LCS18020/1435.24	180	2,0/1,4	35		24
LCS18025/1635.24	180	2,5/1,6	35		24
LCS18030/2035.24	180	3,0/2,0	35		24
LCS18035/2535.24	180	3,5/2,5	35		24
LCS18040/2835.24	180	4,0/2,8	35		24
LCS18050/4035.24	180	5,0/4,0	35		24
LCS18060/4035.24	180	6,0/4,0	35		24
LCS18070/6035.24	180	7,0/6,0	35		24
LCS18080/6035.24	180	8,0/6,0	35		24
LCS18090/6035.24	180	9,0/6,0	35		24
LCS180100/6035.24	180	10,0/6,0	35		24
LCS20030/2030.32	200	3,0/2,0	30		32
LCS20040/2830.32	200	4,0/2,8	30		32
LCS20050/4030.32	200	5,0/4,0	30		32
LCS20060/4030.32	200	6,0/4,0	30		32
LCS25030/2030.40	250	3,0/2,0	30		40
LCS25040/2830.40	250	4,0/2,8	30		40
LCS25050/4030.40	250	5,0/4,0	30		40
LCS25060/4030.40	250	6,0/4,0	30		40
LCS30040/2830.48	300	4,0/2,8	30		48
LCS30060/4030.48	300	6,0/4,0	30		48

## LAMA CIRCOLARE PER ALLUMINIO TAGLIENTI NEGATIVI

Circular saw blades for aluminium negative cut

Kreissägeblatt für ne-metalle - negative zahn

Hoja de sierra para el corte de metals ligeros con corte negativo

Дисковая пила для обработки алюминия с отрицательным углом

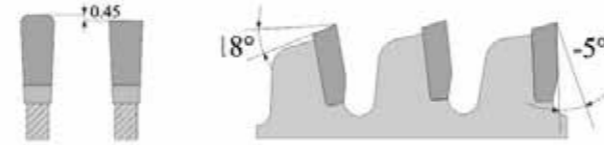

Codice	D	B/b	d	FT	Z
LCAN20032/2520.64	200	3,2/2,5	20	2 11 63	64
LCAN25034/2630.60	250	3,4/2,6	30	2 11 63	60
LCAN25034/2632.60	250	3,4/2,6	32	2 11 63	60
LCAN25034/2630.80	250	3,4/2,6	30	2 11 63	80
LCAN25034/2632.80	250	3,4/2,6	32	2 11 63	80
LCAN27534/2632.84	275	3,4/2,6	32	2 11 63	84
LCAN30034/2630.72	300	3,4/2,6	30	2 11 63	72
LCAN30034/2632.72	300	3,4/2,6	32	2 11 63	72
LCAN30034/2630.84	300	3,4/2,6	30	2 11 63	84
LCAN30034/2632.84	300	3,4/2,6	32	2 11 63	84
LCAN30034/2630.96	300	3,4/2,6	30	2 11 63	96
LCAN30034/2632.96	300	3,4/2,6	32	2 11 63	96
LCAN33034/2630.96	330	3,4/2,6	30	2 11 63	96
LCAN35034/2630.84	350	3,4/2,6	30	2 11 63	84
LCAN35034/2632.84	350	3,4/2,6	32	2 11 63	84
LCAN35034/2630.96	350	3,4/2,6	30	2 11 63	96
LCAN35034/2632.96	350	3,4/2,6	32	2 11 63	96
LCAN35034/2630.108	350	3,4/2,6	30	2 11 63	108
LCAN35034/2632.108	350	3,4/2,6	32	2 11 63	108
LCAN38038/3030.96	380	3,8/3,0	30	2 11 63	96
LCAN40040/3230.96	400	4,0/3,2	30	2 11 63	96
LCAN40040/3232.96	400	4,0/3,2	32	2 11 63	96

## LAMA CIRCOLARE PER ALLUMINIO TAGLIENTI NEGATIVI

Circular saw blades for aluminium negative cut

Kreissägeblatt für ne-metalle - negative zahn

Hoja de sierra para el corte de metals ligeros con corte negativo

Дисковая пила для обработки алюминия с отрицательным углом

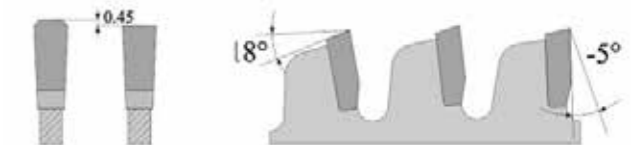

Codice	D	B/b	d	FT	Z
LCAN40040/3230.108	400	4,0/3,2	30	2 11 63	108
LCAN40040/3232.108	400	4,0/3,2	32	2 11 63	108
LCAN40040/3230.120	400	4,0/3,2	30	2 11 63	120
LCAN40040/3232.120	400	4,0/3,2	32	2 11 63	120
LCAN42040/3230.96	420	4,0/3,2	30	2 11 63	96
LCAN43040/3230.96	430	4,0/3,2	30	2 11 63	96
LCAN45040/3230.96	450	4,0/3,2	30	2 11 63	96
LCAN45040/3232.96	450	4,0/3,2	32	2 11 63	96
LCAN45040/3230.108	450	4,0/3,2	30	2 11 63	108
LCAN45040/3232.108	450	4,0/3,2	32	2 11 63	108
LCAN45040/3230.128	450	4,0/3,2	30	2 11 63	128
LCAN45040/3232.128	450	4,0/3,2	32	2 11 63	128
LCAN50046/3630.120	500	4,6/3,6	30	2 11 63	120
LCAN50046/3632.120	500	4,6/3,6	32	2 11 63	120
LCAN50046/3630.140	500	4,6/3,6	30	2 11 63	140
LCAN50046/3630.156	500	4,6/3,6	30	2 11 63	156
LCAN55046/3630.140	550	4,6/3,6	30	2 11 63	140
LCAN55046/3630.172	550	4,6/3,6	30	2 11 63	172
LCAN60046/3630.140	600	4,6/3,6	30	2 11 63	140
LCAN60046/3630.186	600	4,6/3,6	30	2 11 63	186

## LAMA CIRCOLARE PER ALLUMINIO TAGLIENTI POSITIVI

Circular saw blades for aluminium positive cut

Kreissägeblatt für ne-metalle - positive zahn

Hoja de sierra para el corte de metals ligeros con corte positivo

Дисковая пила для обработки алюминия с положительным углом



Codice	D	B/b	d	FT	Z
LCAP20032/2520.64	200	3,2/2,5	20	2 11 63	64
LCAP25034/2630.60	250	3,4/2,6	30	2 11 63	60
LCAP25034/2632.60	250	3,4/2,6	32	2 11 63	60
LCAP25034/2630.80	250	3,4/2,6	30	2 11 63	80
LCAP25034/2632.80	250	3,4/2,6	32	2 11 63	80
LCAP27534/2632.84	275	3,4/2,6	32	2 11 63	84
LCAP30034/2630.72	300	3,4/2,6	30	2 11 63	72
LCAP30034/2632.72	300	3,4/2,6	32	2 11 63	72
LCAP30034/2630.84	300	3,4/2,6	30	2 11 63	84
LCAP30034/2632.84	300	3,4/2,6	32	2 11 63	84
LCAP30034/2630.96	300	3,4/2,6	30	2 11 63	96
LCAP30034/2632.96	300	3,4/2,6	32	2 11 63	96
LCAP35034/2630.84	350	3,4/2,6	30	2 11 63	84
LCAP35034/2632.84	350	3,4/2,6	32	2 11 63	84
LCAP35034/2630.96	350	3,4/2,6	30	2 11 63	96
LCAP35034/2632.96	350	3,4/2,6	32	2 11 63	96
LCAP35034/2630.108	350	3,4/2,6	30	2 11 63	108
LCAP35034/2632.108	350	3,4/2,6	32	2 11 63	108
LCAP40040/3230.96	400	4,0/3,2	30	2 11 63	96

## LAMA CIRCOLARE PER ALLUMINIO TAGLIENTI POSITIVI

Circular saw blades for aluminium positive cut

Kreissägeblatt für ne-metalle - positive zahn

Hoja de sierra para el corte de metals ligeros con corte positivo

Дисковая пила для обработки алюминия с положительным углом

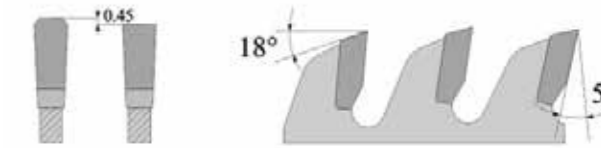

Codice	D	B/b	d	FT	Z
LCAP40040/3232.96	400	4,0/3,2	32	2 11 63	96
LCAP40040/3230.108	400	4,0/3,2	30	2 11 63	108
LCAP40040/3232.108	400	4,0/3,2	32	2 11 63	108
LCAP40040/3230.120	400	4,0/3,2	30	2 11 63	120
LCAP40040/3232.120	400	4,0/3,2	32	2 11 63	120
LCAP42040/3230.96	420	4,0/3,2	30	2 11 63	96
LCAP45040/3230.96	450	4,0/3,2	30	2 11 63	96
LCAP45040/3232.96	450	4,0/3,2	32	2 11 63	96
LCAP45040/3230.108	450	4,0/3,2	30	2 11 63	108
LCAP45040/3232.108	450	4,0/3,2	32	2 11 63	108
LCAP45040/3230.128	450	4,0/3,2	30	2 11 63	128
LCAP45040/3232.128	450	4,0/3,2	32	2 11 63	128
LCAP45040/3230.140	450	4,0/3,2	30	2 11 63	140
LCAP50046/3630.120	500	4,6/3,6	30	2 11 63	120
LCAP50046/3632.120	500	4,6/3,6	32	2 11 63	120
LCAP50046/3630.140	500	4,6/3,6	30	2 11 63	140
LCAP55046/3630.120	550	4,6/3,6	30	2 11 63	120
LCAP55046/3630.140	550	4,6/3,6	30	2 11 63	140
LCAP60046/3630.140	600	4,6/3,6	30	2 11 63	140



**ILMA INNOVATION SYSTEMS S.r.l.**

Via Progresso, 119 - 36035 Marano Vicentino (VI) Italy

T. +39 0445 510455 | Fax +39 0445 518553

[ilma@ilmaitalia.com](mailto:ilma@ilmaitalia.com) | [www.ilmaitalia.com](http://www.ilmaitalia.com)

**CATALOGO 2019**